

Nitrogen flows from European regional watersheds to coastal marine waters

Lead author: **Gilles Billen**

Contributing authors: **Marie Silvestre, Bruna Grizzetti, Adrian Leip, Josette Garnier, Maren Voss, Robert Howarth, Fayçal Bouraoui, Ahti Lepistö, Pirkko Kortelainen, Penny Johnes, Chris Curtis, Christoph Humborg, Erik Smedberg, Øyvind Kaste, Raja Ganeshram, Arthur Beusen and Christiane Lancelot**

Executive summary

Nature of the problem

- Most regional watersheds in Europe constitute managed human territories importing large amounts of new reactive nitrogen.
- As a consequence, groundwater, surface freshwater and coastal seawater are undergoing severe nitrogen contamination and/or eutrophication problems.

Approaches

- A comprehensive evaluation of net anthropogenic inputs of reactive nitrogen (NANI) through atmospheric deposition, crop N fixation, fertiliser use and import of food and feed has been carried out for all European watersheds. A database on N, P and Si fluxes delivered at the basin outlets has been assembled.
- A number of modelling approaches based on either statistical regression analysis or mechanistic description of the processes involved in nitrogen transfer and transformations have been developed for relating N inputs to watersheds to outputs into coastal marine ecosystems.

Key findings/state of knowledge

- Throughout Europe, NANI represents 3700 kgN/km²/yr (range, 0–8400 depending on the watershed), i.e. five times the background rate of natural N₂ fixation.
- A mean of approximately 78% of NANI does not reach the basin outlet, but instead is stored (in soils, sediments or ground water) or eliminated to the atmosphere as reactive N forms or as N₂.
- N delivery to the European marine coastal zone totals 810 kgN/km²/yr (range, 200–4000 depending on the watershed), about four times the natural background. In areas of limited availability of silica, these inputs cause harmful algal blooms.

Major uncertainties/challenges

- The exact dimension of anthropogenic N inputs to watersheds is still imperfectly known and requires pursuing monitoring programmes and data integration at the international level.
- The exact nature of 'retention' processes, which potentially represent a major management lever for reducing N contamination of water resources, is still poorly understood.
- Coastal marine eutrophication depends to a large degree on local morphological and hydrographic conditions as well as on estuarine processes, which are also imperfectly known.

Recommendations

- Better control and management of the nitrogen cascade at the watershed scale is required to reduce N contamination of ground- and surface water, as well as coastal eutrophication.
- In spite of the potential of these management measures, there is no choice at the European scale but to reduce the primary inputs of reactive nitrogen to watersheds, through changes in agriculture, human diet and other N flows related to human activity.

13.1 Introduction

A regional territory comprises a number of natural, semi-natural and artificial landscapes, themselves composed of a mosaic of interacting ecosystems. The preceding chapters in this volume have emphasised that the complexity of landscape interactions, often occurring at the interface between ecosystems, prevents a simple additive approach to the functioning of large systems and their nitrogen budget; this is particularly true for regional territories. A regional watershed can be defined as a territory structured by a drainage network. Defining the limits of a territory in accordance with the limits of a watershed simplifies budgeting approaches, as it allows a direct estimate of export through the hydrosystem, which is one of the major output terms in the nitrogen budget. However, this simple matter of budgeting convenience is not the sole reason to focus a discussion of the nitrogen cascade on the scale of regional watersheds. Indeed, drainage networks historically played a major role in structuring the European geographical space, often determining city settlement locations, the commercial

exchanges between them and the surrounding rural areas, hence the development of agriculture. Regional watersheds are therefore pertinent spatial units for studying the interactions between humans and the environment. Moreover, the coastal marine systems located at the outlet of regional watersheds are strongly influenced by the fluxes of water and nutrients delivered by the river, so that the whole continuum of ecosystems, including the catchments' terrestrial systems, the drainage network, the estuarine zone and the coastal sea, should all be viewed and managed as a single integrated system. This is the point of view adopted in the present chapter.

The major European watersheds are shown in Figure 13.1, grouped according to the marine coastal zones where they discharge. The full database of European watersheds used for this study is available as on-line supplementary material (see Supplementary materials, Section 13.7). It includes 5872 individual catchments, most of them very small rivers. The major ones, with an area larger than 10 000 km², account for 67% of the total European coastal watershed area.

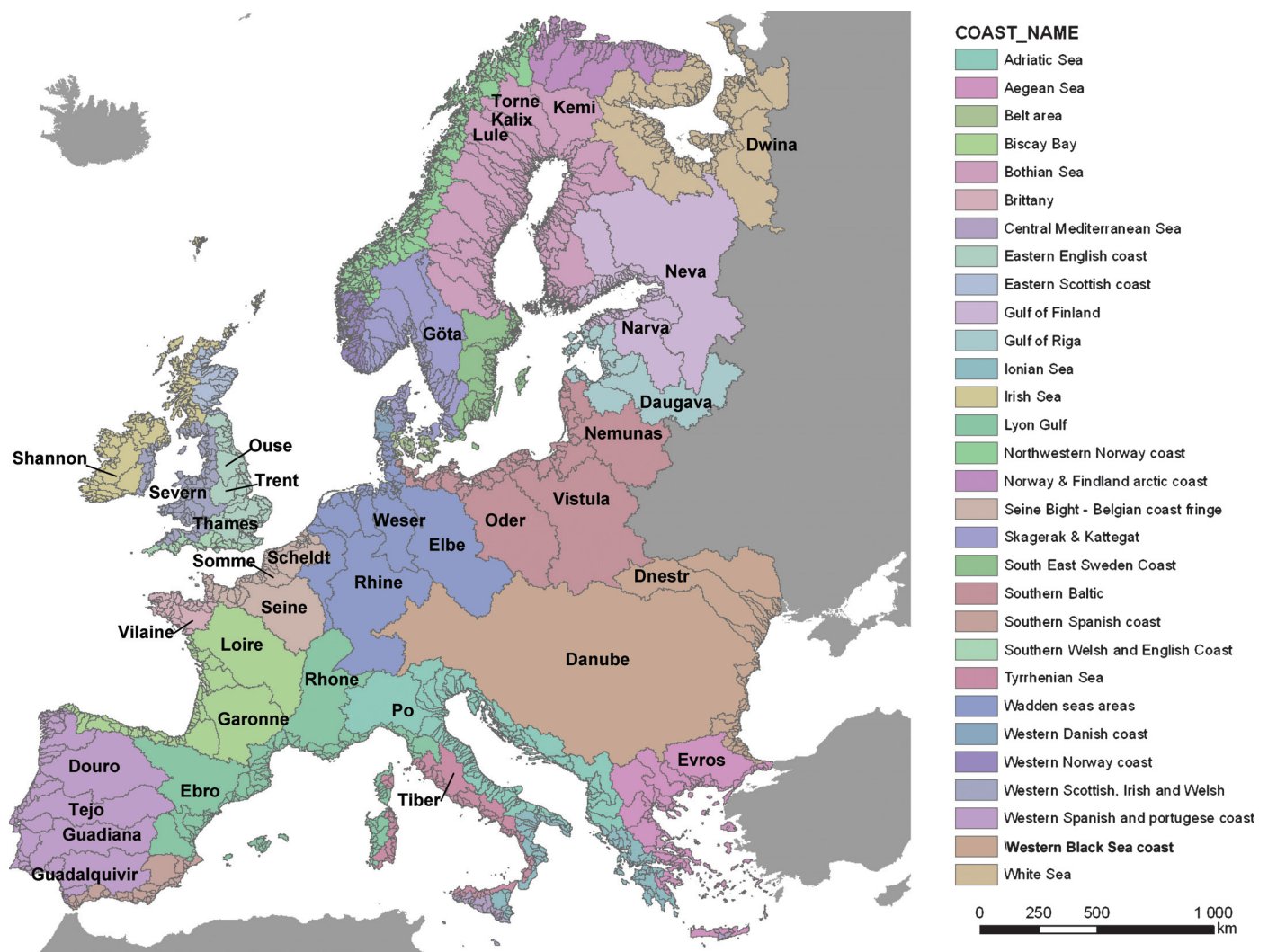

Figure 13.1 Major regional watersheds in Europe and their receiving coastal marine systems.

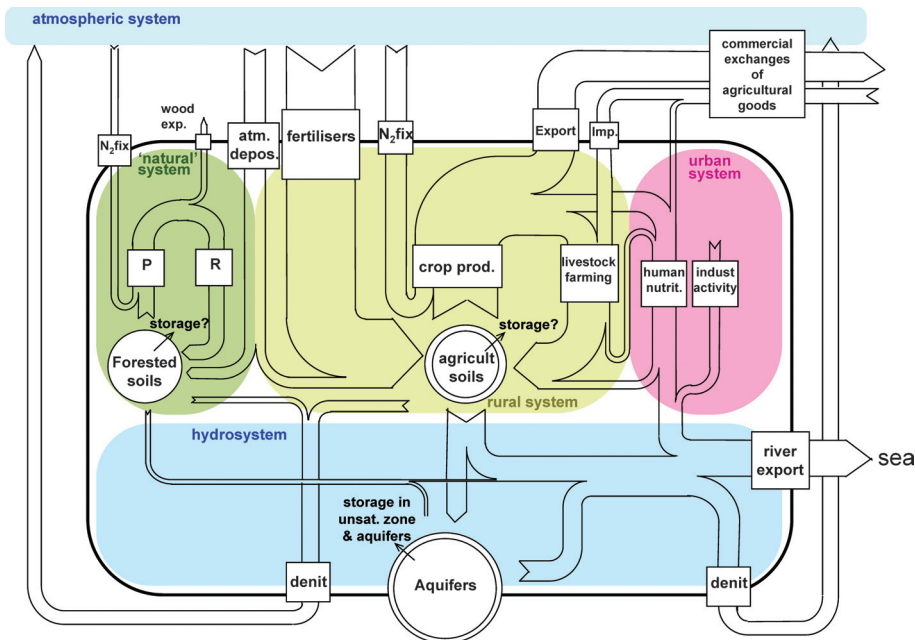

Figure 13.2 Schematic representation of the flows of reactive nitrogen through a regional watershed.

In this chapter, the nitrogen cascade will be examined at the scale of the major watersheds in Europe. The fate of reactive nitrogen brought into these regional territories through atmospheric deposition, synthetic fertiliser application, crop nitrogen fixation and commercial import of food and feed will be discussed at the regional basin scale. Particular emphasis will be placed on the riverine transfer of nitrogen from the terrestrial watershed to ground, surface and marine coastal waters, and on the consequences for the health of the marine systems.

The analysis will be guided by the conceptual representation of nitrogen transfers through the different components of a regional watershed illustrated in Figure 13.2. Although this figure does not show all the complex interactions between the different components of the system, it clearly indicates the major sources of reactive nitrogen, the three major types of nitrogen output (to the atmosphere in its gaseous form, to other territories as food and feed, to the coastal seas as river loading) and the major pools with a long residence time (soils and aquifers) where nitrogen can be stored (and possibly remobilised) within the system.

We will first establish the reactive nitrogen input–output budget of European watersheds and discuss the difference, often improperly termed ‘retention’, between total inputs and riverine outputs to the coastal zone. We then will take stock of the various modelling approaches used at the regional scale for relating nitrogen inputs to riverine outputs. Using both model results and observed fluxes, we will then examine the long-term trends of nitrogen riverine delivery, and its relations with phosphorus and silica, which is the key to understanding their potential for coastal marine eutrophication. The role of estuaries, acting as the last filter before delivery to the sea, will be briefly examined, prior to discussing the state of eutrophication of European coastal zones.

13.2 Input–output nitrogen budgets of regional watersheds

13.2.1 Inputs to watersheds

As depicted in Figure 13.2, reactive nitrogen is brought into watersheds from atmospheric deposition, crop N_2 fixation and synthetic fertiliser use, as well as by net commercial import of food and feed. All these terms are estimated at a rather fine geographical resolution scale for the whole of Europe, as discussed by Leip *et al.* (2011, Chapter 16, this volume). We present here only a short summary of these data.

Data on atmospheric deposition of nitrogen as nitrogen oxides and as ammonium are available from the calculation of the EMEP project. Owing to the much shorter residence time of NH_3 than nitrogen oxides in the atmosphere, a large part of deposited reduced nitrogen is short-distance re-deposition of emitted ammonia. Therefore, for the purposes of estimating net input of N to large watersheds, local emissions of ammonium by agricultural sources should be subtracted from deposition figures, or, as often done, only the figures for oxidised nitrogen deposition should be considered. Synthetic fertiliser application rates are calculated from the CAPRI database, which is fed by the national fertiliser application rate by crop, communicated by EFMA (European Fertilizers Manufacturers Association). Crop N_2 fixation is evaluated from the data on legume crop and grassland distribution considering their respective rates of N_2 fixation.

As also discussed by Leip *et al.* (2011, Chapter 16, this volume), net commercial input/output of nitrogen as agricultural goods can be deduced from a budget of food and feed production by agriculture (autotrophy) *versus* local consumption by human and domestic animals (heterotrophy), both fluxes being expressed in terms of nitrogen (Billen *et al.*, 2007, 2009a,

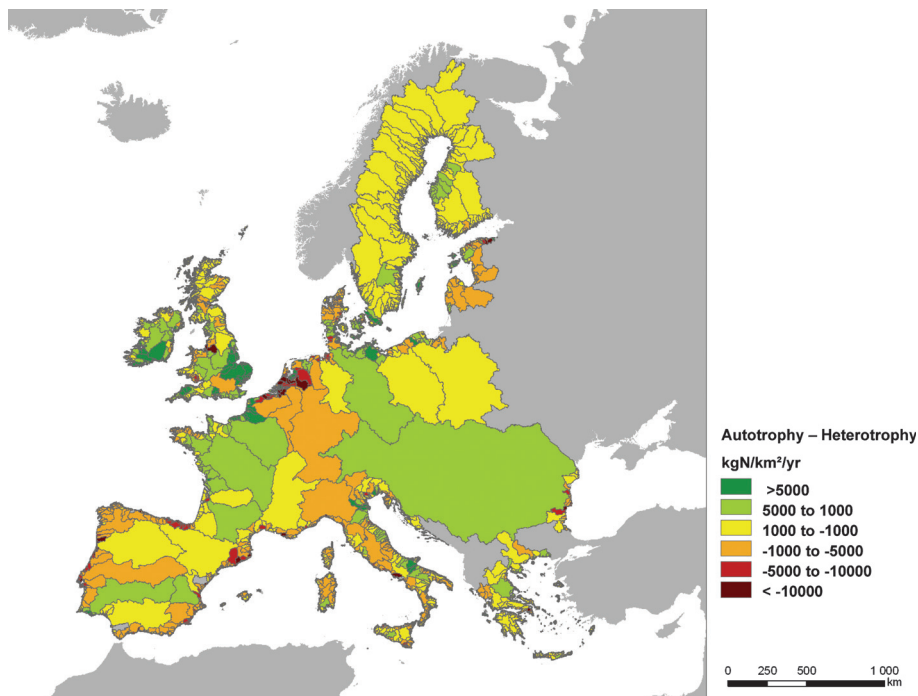

Figure 13.3 Distribution of the balance between autotrophy and heterotrophy of the main watersheds across Europe (EU-27) (as calculated from the CAPRI-DNDC database, Leip *et al.*, 2011, Chapter 16, this volume). Green watersheds have an autotrophic status, while orange or red areas represent systems with heterotrophic status; yellow watersheds are balanced.

2010). Urban areas, where food is consumed but not produced, are obviously of dominant heterotrophic status. Rural regions specialised in crop farming and exporting their production to distant markets have an autotrophic status, while those which orient their agricultural activities towards intensive animal farming based on the import of feed from other regions have a heterotrophic status (Figure 13.3).

When applied to European watersheds, this approach shows basins such as the Scheldt or the Po which have a strongly heterotrophic status, while basins such as the Seine or the Somme are highly autotrophic systems (Figure 13.4). Based on agricultural data from the second half of the twentieth century, Figure 13.4 shows the opposite trends in the historical trajectory of two exemplary basins, the Seine and the Scheldt, during the past 50 years: the former, turning towards exclusive cereal farming, become more and more autotrophic, while the latter, specialised in intensive animal husbandry, increased its heterotrophic status. These trends are important from the perspective of the nitrogen cascade, since the dominant source of nitrogen in autotrophic watersheds consists of inorganic fertilisers, while organic forms of nitrogen dominate in the nitrogen inputs to watersheds with heterotrophic status, which modifies the subsequent cascading nitrogen pathways.

Summing up all the atmospheric deposition, fertiliser application and N_2 fixation data, as well as the above-calculated net commercial imports (or exports) of nitrogen as food and feed, the net anthropogenic nitrogen input (NANI, Howarth *et al.*, 1996) to each European watershed can be calculated. Expressed per square kilometre, it represents the intensity of anthropogenic disturbance of the N cycle by introduction of reactive nitrogen into the biosphere at the regional basin scale (Figure 13.5). Values range from a few tens of $kgN/km^2/yr$ in Scandinavian watersheds, where atmospheric deposition dominates the total, to over 10 000 $kgN/km^2/yr$ in watersheds

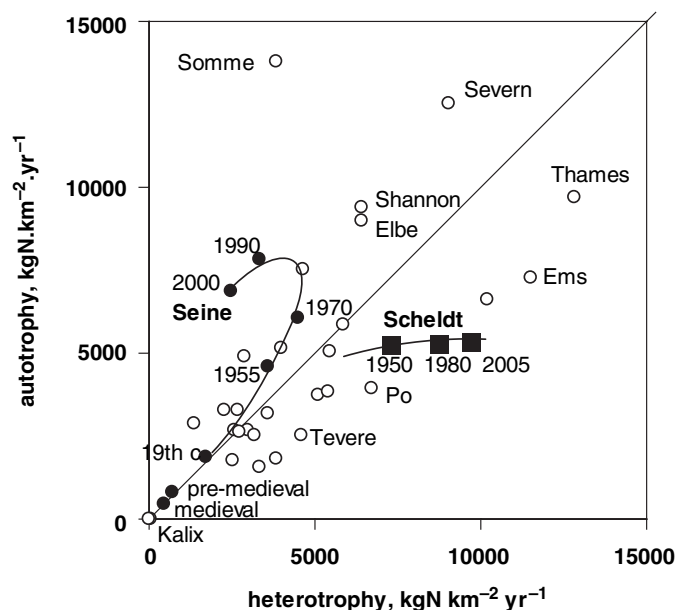

Figure 13.4 Autotrophy/heterotrophy diagram showing the historical trajectory of the Seine (●) and Scheldt (■) watersheds (Billen *et al.*, 2009b). Autotrophy represents the agricultural production of food and feed, while heterotrophy represents local human and livestock consumption. The position of a number of other European basins (○) is also shown.

bordering the North Sea, where either fertilisers or commercial imports of feed dominate, depending on their autotrophic or heterotrophic status.

Net total nitrogen inputs (NTNI) to watersheds can also be defined; this differs from NANI by the natural rate of atmospheric nitrogen fixation both by lightning and by biological N_2 fixation in the soils of natural ecosystems. In Europe this rate has been evaluated at 1.5–2.5 $kgN/ha/yr$ in Scandinavian forests, 5–25 $kgN/ha/yr$ in temperate forests and 10–35 $kgN/ha/yr$

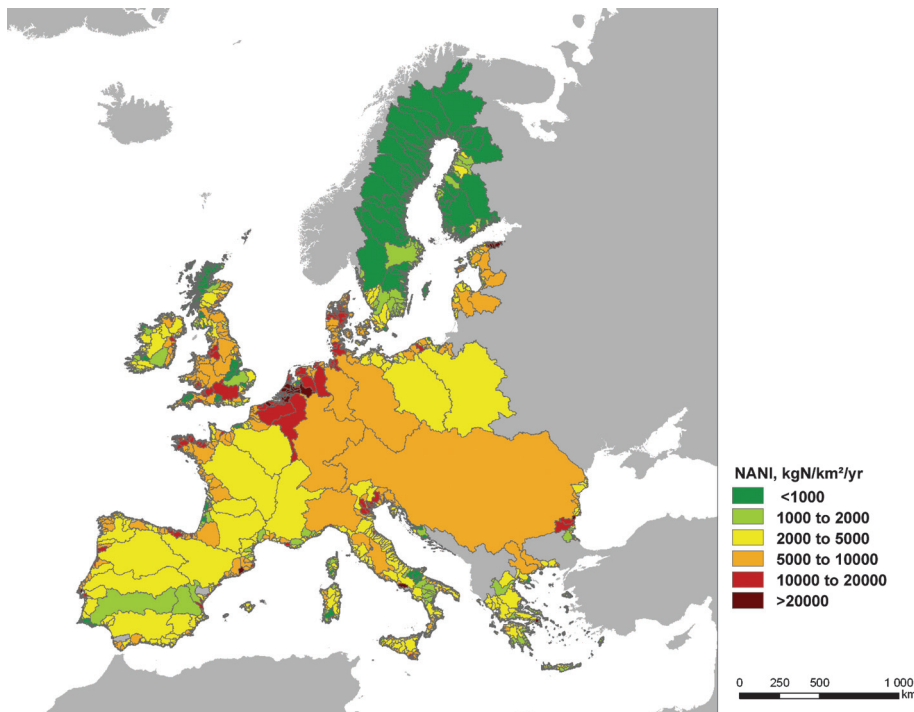

Figure 13.5 Basin averaged net anthropogenic nitrogen inputs to European watersheds, based on CAPRI-DNDC data (Leip *et al.*, 2011, Chapter 16, this volume).

in Mediterranean shrubland, based on the compilation by Cleveland *et al.* (1999).

13.2.2 Observed riverine nitrogen fluxes at the catchment outlet

A database of nutrient fluxes delivered from large European watersheds at their outlet into estuarine/coastal waters has been assembled as part of NinE activities. The database (available as on-line supplementary material, see Section 13.7) includes recent data on total N, P and Si fluxes. Typically, average values of annual fluxes observed between 1995 and 2005 are recorded. When only inorganic nitrogen data were available, total nitrogen was estimated using the relationship between TN and DIN discussed by Durand *et al.* (2011, Chapter 6, this volume). Figure 13.6 summarises the available data. Documented watersheds in the NinE database cover 69% of the total European watershed area. Nitrogen delivery rates range from less than 200 to more than 4000 kgN/km²/yr.

Total nitrogen fluxes exported from small watersheds may be even higher, with values over 10 000 kgN/km²/yr. Figure 13.7 shows that values higher than 2000 kgN/km²/yr are always associated with the presence of agriculture as a major share of land use in the catchment, although the exported nitrogen fluxes from watersheds with the same percentage of agricultural land may vary greatly, reflecting differences in agricultural practices (including the proportion of low-intensity grazing) as well as climatic and hydrological conditions.

13.2.3 Overall 'retention' within regional watersheds

Comparing the data in Figures 13.5 and 13.6 immediately shows that only a limited fraction of the total anthropogenic

inputs of nitrogen to watersheds is actually exported by the river to the coastal zone. Although misleading, the term 'retention' is used extensively in the literature to designate all the processes preventing nitrogen load (i.e. NTNI) to a watershed being transferred to the outlet of the drainage network (Dillon *et al.*, 1990; Howarth *et al.*, 1996; Windolf *et al.*, 1996; Arheimer, 1998; Lepistö *et al.*, 2001). It accounts for the net effect of various biogeochemical processes responsible for temporary or permanent N removal from the water phase (such as biological uptake and biomass production, sedimentation and denitrification) or N removal from the land phase (such as gaseous losses by denitrification and nitrification, volatilisation and N storage in permanent vegetation, soils and groundwater).

Howarth *et al.* (1996, 2006), Boyer *et al.* (2002) and Alexander *et al.* (2002) showed that the flux of nitrogen exported by North American and Western European watersheds, over a background export of 107 kgN/km²/yr, accounts for a mean 26% of net anthropogenic nitrogen inputs (NANI), implying that 74% of the anthropogenically introduced nitrogen is retained or eliminated in the watershed. The data gathered in the NinE database allow testing this empirical relationship for the European watersheds for which an estimate of N delivery at the outlet is available (Figure 13.8a). Apparent retention, expressed as the fraction of NANI, varies from 90% to 50%, with a mean value of 82%. The regression of N delivery *versus* NANI is, however, highly significant:

$$\text{Nflx (kgN/km}^2\text{/yr)} = 0.18 * \text{NANI (kgN/km}^2\text{/yr)} + 228 \quad (r^2=0.58) \quad (13.1)$$

The modelled background nitrogen export of 228 kgN/km²/yr, although burdened with substantial uncertainty

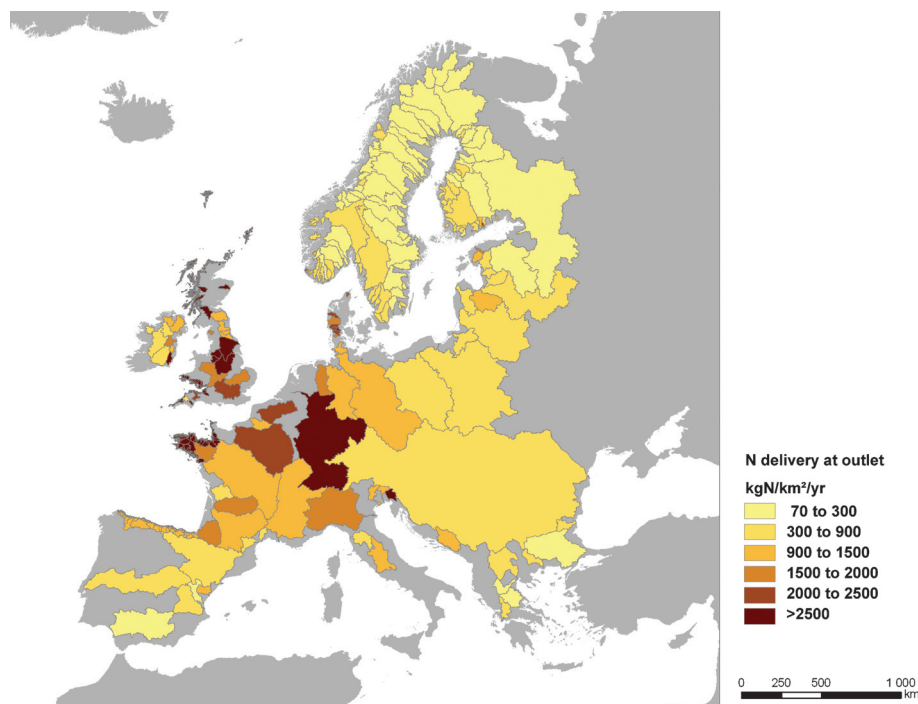

Figure 13.6 Available observed data on N delivery by European watersheds. Data from Humborg *et al.* (2003, 2006, 2008); Radach and Pätzsch (2007); Lancelot *et al.* (1991); Billen *et al.* (2009a, b); Neal and Davies (2003); Meybeck *et al.* (1988); Ludwig *et al.* (2009); Cociasu *et al.* (1996); Johnes and Butterfield (2002); OSPAR (2002); REGINE (2010). See online supplementary material (Section 13.7) for original data.

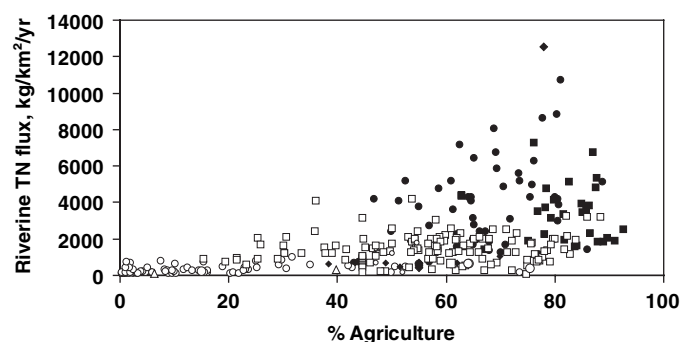

Figure 13.7 Exported total nitrogen fluxes at the outlet of small to medium-sized watersheds from different areas of Europe as a function of the share of agricultural land (arable land and managed grassland) in total land cover. (data from Baltic countries (○), Germany and Czech Rep (□), United Kingdom (■), France (●) and the Netherlands (◆)).

(± 100 kgN/km²/yr), agrees well with the experimental data from the boreal zone (Mattsson *et al.*, 2003; Kortelainen *et al.*, 2006; see below).

Looking further to the variability of the retention factor, Howarth *et al.* (2006) found that it could be correlated with a simple climate variable such as precipitation or discharge (Q), with retention decreasing from 95% to 40% of total NANI when the specific discharge increases from 100 to 800 mm/yr in North American watersheds. The even more pronounced effect of specific discharge on N retention was also underlined by Behrendt and Opitz (2000) and Billen *et al.* (2009b). A sigmoid relationship of runoff has been proposed by Billen *et al.* (2010) for world watersheds. From the data presented in Figure 13.8a, no clear relationship of retention with specific runoff emerges, which could explain the variability observed around relation (13.1), although a

trend around a sigmoid relationship of discharge is observed when the data are grouped into Scandinavian, temperate or Mediterranean river systems (Figure 13.8b). Other factors such as variability in temperature- and soil moisture-induced biogeochemical processes in watershed soils are likely to play a role as well. The presence of lakes and their location in the watershed with respect to the outlet are also important factors contributing to overall retention (Arheimer and Brandt, 1998; Lepistö *et al.*, 2006).

On the basis of relationship (13.1), it is possible to use the distributed data on NANI (Figure 13.5) to calculate the most likely value of riverine-specific nitrogen delivery by undocumented European watersheds, thus interpolating the observed data of Figure 13.6. The overall nitrogen riverine delivery and retention for the watersheds of the major coastal areas of Europe calculated on this basis are summarised in Table 13.1.

According to this analysis, the total flux of nitrogen discharged by rivers into European coastal waters is 4760 ktonN/yr, accounting for 22% of the total amount of new nitrogen brought by anthropogenic processes to the corresponding watersheds (21 550 kton/yr).

Although sizeable uncertainties affect these estimations, they clearly show the extreme perturbation of the N cycle in most European watersheds. They also stress that water resources contamination is only one of many important pathways of the cascade followed by anthropogenic nitrogen introduced into regional watersheds. Understanding and predicting the relation between N-related human activities in a watershed and the amount of N transferred by the hydrosystem is therefore a key scientific question. It is also a major management issue, as many measures can potentially act on retention processes.

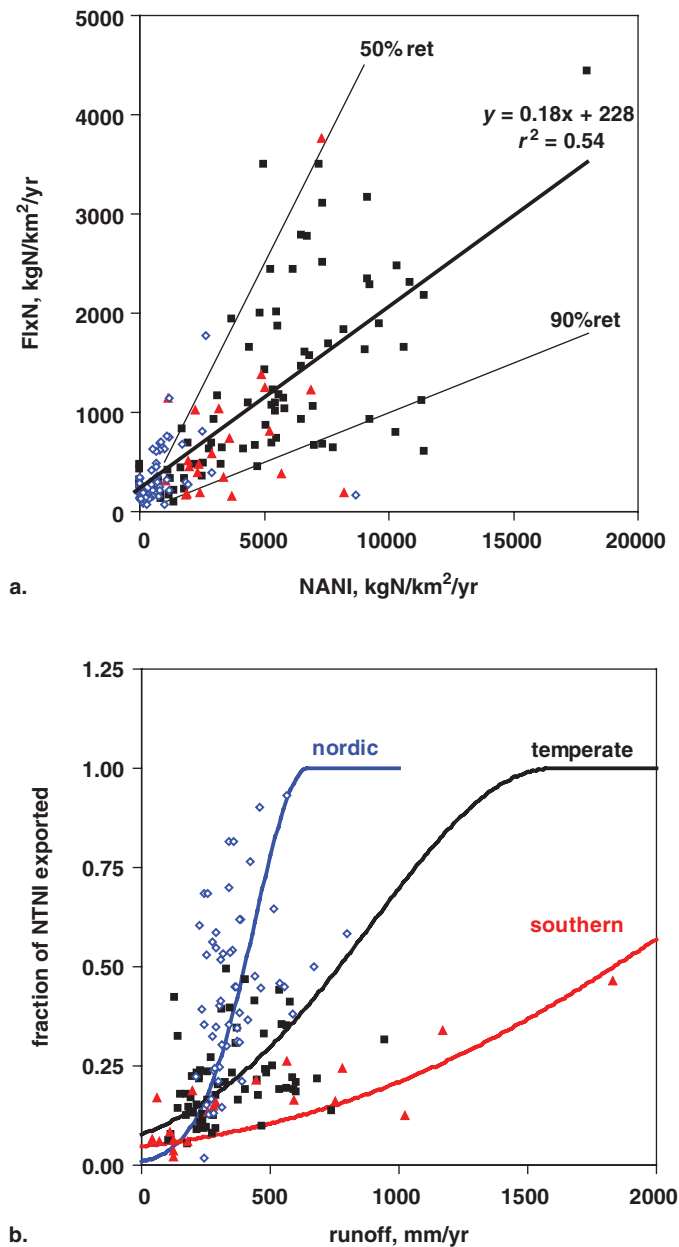

Figure 13.8 (a) Specific N flux delivered at the outlet of European watersheds as a function of the net anthropogenic nitrogen inputs (NANI). The heavy line represents the regression across all points. The lighter lines represent N retention of 50% and 90% of NANI. (b) Fraction of NTNI delivered at the outlet as a function of runoff for Scandinavian (◇), temperate (■) and Mediterranean (▲) watersheds. The line represents the best fit of the sigmoid relationship proposed by Billen *et al.* (2010): $\text{fraction NTNI exported} = \exp(-(Q-Q_m)^2/Q_s^2)$, where Q is the mean specific runoff (mm/yr) of each watershed and Q_m and Q_s are climate-specific parameters.

13.3 Modelling N fluxes through watersheds

13.3.1 Point and diffuse sources of nitrogen to the hydrosystem

The above NANI approach is based on a pure black-box input-output budget of the watershed as a whole. It quantifies the overall retention without identifying the processes responsible for it. In particular, it does not distinguish between terrestrial and

aquatic processes of nitrogen retention and makes no difference between the pathways through which nitrogen inputs are introduced to the hydrosystem, either as diffuse processes on the terrestrial watershed or as discrete point injection directly into the drainage network (Figure 13.9). This distinction between diffuse and point sources of nitrogen is important because different retention processes act on each of them: landscape processes including storage in soil organic matter or biomass pools, soil denitrification or ammonia volatilisation, storage in deep aquifers, etc., act on diffuse sources of nitrogen. In-stream processes, including river bed denitrification or sediment storage, act on point sources and on diffuse sources after the action of landscape processes.

Identifying and quantifying the various pathways of nitrogen contamination of and transformation in hydrosystems is therefore of prime importance for understanding the nitrogen cascade at the regional scale. Various models have been developed for this purpose and will be briefly described in the following section. To implement them, detailed data on point and non-point sources of nutrients to the hydrosystem are required. As far as point sources of nitrogen from urban wastewater are concerned, a detailed inventory is available at the European scale, thanks to the efforts of the EC within the implementation of the Water Framework Directive (Bouraoui *et al.*, 2009). The geographical pattern shown (Figure 13.10) closely follows the distribution of large cities across Europe, with the transversal dorsal of rich cities extending from Birmingham to Milan ('The Blue Banana', Brunet, 2002).

The definition of diffuse sources depends considerably on the particular model used, as will be shown below.

13.3.2 A typology of models for regional watershed N transfers

A large number of models have been used for quantifying nutrient transport and retention at the regional river-basin scale, which relies on a wide range of different assumptions and different methods for the description of nutrient sources, catchment characteristics and the physical and biogeochemical processes involved. Table 13.2 lists a number of such models, with their general basic equations and principles, their required input data and a list of watersheds where they have been applied.

All models have been validated in diverse catchment areas and all are capable of satisfactorily predicting nutrient export from land use and point inputs, but they differ in the system boundaries, their spatial resolution, the complexity of their representation of the processes and their temporal resolution.

A first difference lies in the definition of the system modeled: some models work with the drainage network only; others encompass the entire watershed, including part or all of the soil and groundwater landscape components as well. This difference implies different ways of defining the diffuse sources of nitrogen and of dealing with the nitrogen dynamics in the soil-plant system above the root zone (plant growth, mineralisation, immobilisation, denitrification, etc.). For instance, many models, such as N-EXRET and RivR-N, are typically drainage

Table 13.1 Overall nitrogen input, riverine delivery and percentage retention for the watershed of the major European coastal areas. (The documented area represents the percentage total watershed area for which observed data of nitrogen delivery are available; relationship (13.1) with NANI is used for the undocumented areas, then the overall specific delivery is calculated for the whole coastal zone watershed area.)

	Basin area km ²	Documented %	Specific delivery (weighted average) kgN/km ² /yr	Net input (NANI) ktonN/yr	Total delivery ktonN/yr	Retention of NANI %
Arctic Ocean						
Norway & Finland Arctic coast	122 929	28	192	10	24	—
NW Norway coast	132 905	38	225	11	30	—
White Sea	281 927	0	244	—	69	—
Baltic Sea						
SE Sweden coast	83 974	66	309	116	26	78
Bothnian Sea	499 488	88	211	181	105	42
Gulf of Finland	421 306	90	271	872	114	87
Gulf of Riga	137 846	90	634	712	87	88
S Baltic and Belt area	506 045	86	699	2720	354	87
North Sea						
W Norway coast	47 135	27	339	—	16	—
Skagerak & Kattegat	196 115	80	509	302	100	67
Wadden Seas & W Danish coast	447 931	83	2017	3392	904	73
Seine Bight – Belgian coast fringe	129 219	78	2024	888	262	70
E English & Scottish coast	115 361	48	1502	582	173	70
Atlantic Ocean						
Brittany	34 356	99	2667	289	92	68
Biscay Bay	267 545	92	1175	1217	314	74
Portuguese & W Spanish coasts	370 252	61	623	1202	231	81
W Scottish, Irish & Welsh coasts	134 597	58	1386	473	186	61
S Welsh & English Coast	18 569	14	1374	103	26	75
Irish Sea	42 638	24	1758	303	75	75
S Spanish coast	42 440	0	988	179	42	76
Mediterranean Sea						
Lyon Gulf	305 052	74	811	1135	247	78
Tyrrhenian Sea	74 650	24	1122	359	84	77
Central Mediterranean Sea	13 433	0	995	57	13	77
Ionian Sea	61 775	9	767	193	47	75
Adriatic Sea	237 711	40	1191	1148	283	75
Aegean Sea	155 260	65	530	789	82	90
Black Sea						
W Black Sea coast	991 235	81	782	4317	775	82
Total	5 868 102	69	811	21 550	4761	78

network models which define diffuse inputs of nutrients on the basis of an export coefficient approach, i.e. by associating an empirically determined mean annual nitrogen flux of nutrients to the watershed's different land use classes, without taking into account specific internal soil processes. The Seneque/Riverstrahler model uses a similar approach, except that the mean annual concentrations of surface and base flow

runoff are associated with land use/lithologic classes, these concentrations being either empirically defined or from off-line runs of plant–soil models at the plot or landscape scales, as described by Cellier *et al.* (2011, Chapter 11, this volume). Full watershed models, such as Swat, Inca, Green or EveNFlow, fully integrate a description of the processes occurring in the top soil–plant system and define diffuse sources as the inputs

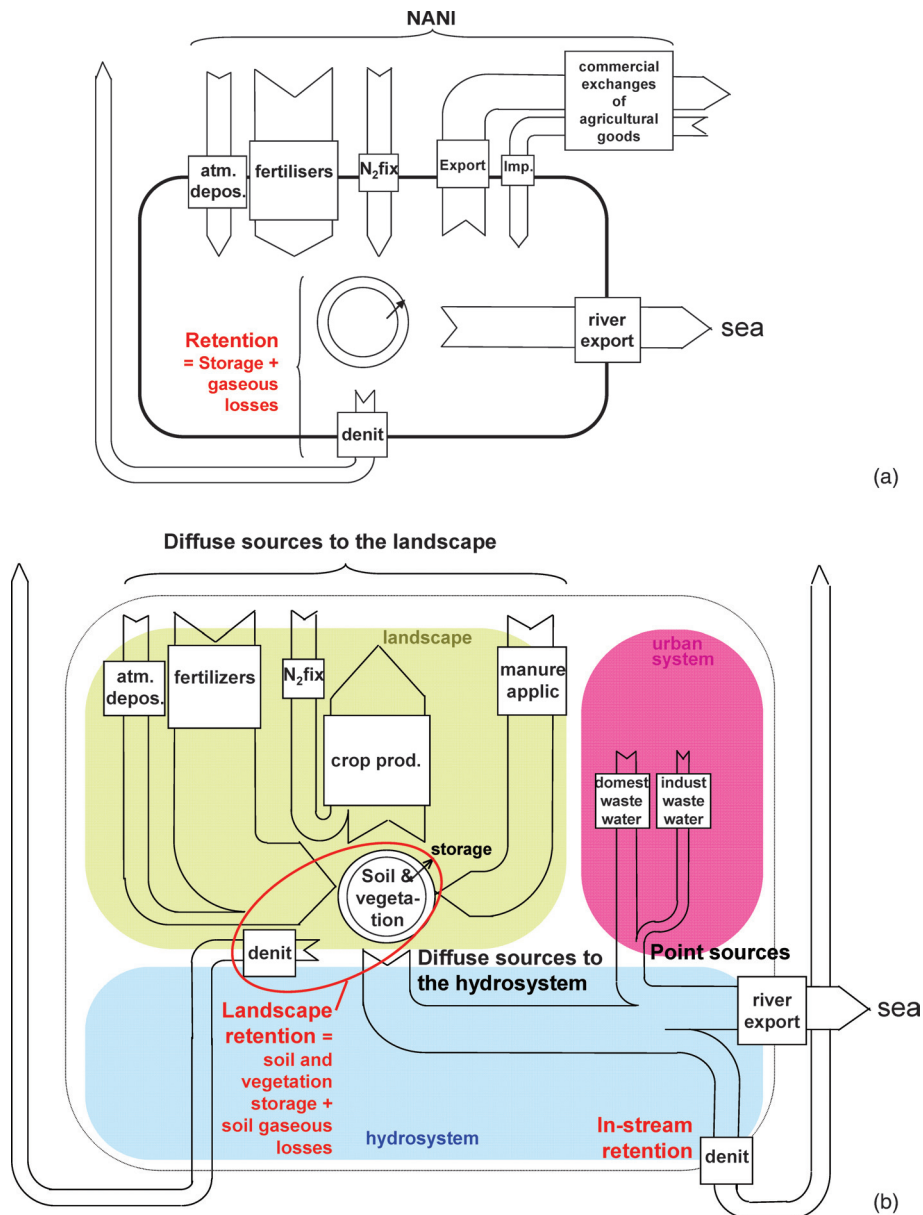

Figure 13.9 Comparison of the input–output view of the watershed behind the black-box NANI approach (a), with a view of the watershed distinguishing between point sources from urban wastewater and diffuse sources from agricultural soils, and considering landscape and in-stream retention processes separately (b). Refer to Figure 13.2 for a more detailed view.

to soil as atmospheric deposition, biological nitrogen fixation, inorganic fertiliser and manure application. The complexity in the description of soil nutrient dynamics varies considerably, however, between these models, from simple regression relationships (e.g. Green) to detailed process modelling (e.g. Swat). Other models, such as Sparrow, Polflow and Moneris, define diffuse sources as the soil nitrogen surplus, i.e. the difference between total inputs to soil and outputs as crop yield, which is assumed to be directly transferred to the hydrosystem.

The spatial resolution also differs widely between the models. Lumped approaches do not consider any spatial distribution of sources and sinks within the watershed; fully distributed models, on the other hand, account for the spatial variability of processes, nutrient inputs and watershed characteristics. The latter obviously require high-resolution spatial referencing of all constraint data, which might be difficult to obtain for large regional applications. Semi-distributed models illustrate the

intermediate case where sub-basins are divided into uniform units (e.g. in terms of land use or vegetation zones) as in the Green or Swat models, or a drainage network into a regular scheme of confluence of tributaries with mean characteristics by stream-order as in the Riverstrahler approach. Most often, depending on data availability and spatial resolution, models may compromise between fully distributed and totally lumped methods, also adapting to the level of process-description details.

Indeed, another major difference between models lies in the complexity of their representation of the processes affecting the nitrogen transfer and transformations, ranging from a very simplified to an extremely complex description. Statistical regression models, such as Green, Sparrow and Polflow, consist in simple correlations of stream monitoring data with watershed sources and landscape properties and provide empirical estimates of nutrient stream export, based on a few explanatory

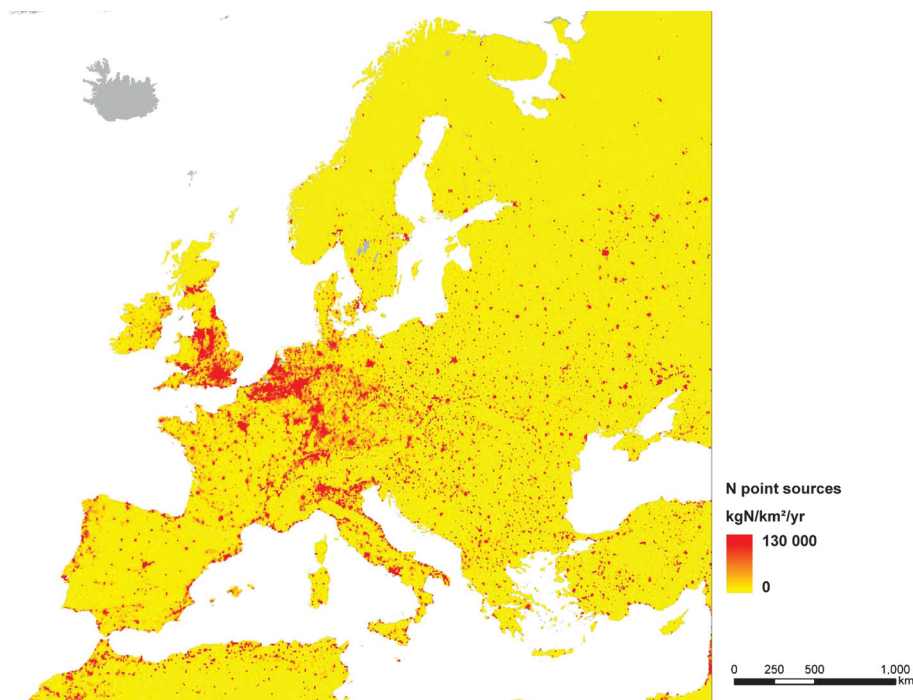

Figure 13.10 N point source emissions (urban communities and industries) on a 1 km² grid over Europe (from Bouraoui *et al.*, 2009).

variables or predictors. The low data and time requirements of such methods explain their popularity for modelling nutrient fate in large river basins. Nevertheless, as soon as forecasting, i.e. explaining and describing the evolution over time of nutrient export and its dependence on the several controlling factors, is needed, mathematical models should be used for mechanistically describing the physical and biogeochemical underlying processes, as in the Inca, Swat and Seneque/Riverstrahler approaches. Owing to their very detailed deterministic description of the processes, these models reduce site specificity to generically explain nutrient transfers with no or minimal need for calibration, hence providing a true understanding of the mechanisms involved. However, the intensive data requirement of such approaches leads to hybrid methods based on empirical relations for quantifying processes whose interactions are mechanistically expressed.

While most regression models only predict mean annual nutrient fluxes, mechanistic models such as Swat, Inca and Seneque/Riverstrahler necessarily take into account seasonal patterns and provide inter-annually and seasonally variable flux and concentration results, which might be of prime importance for assessing the effect on receiving marine ecosystems.

Finally, the models may differ in terms of the variables described, either total N or the different chemical (organic and mineral, dissolved or particulate) forms, and possibly other nutrients such as P and Si.

13.3.3 Comparison of different modelling approaches (EUROHARP)

As illustrated above, a large range of modelling approaches of the nitrogen cascade in large watersheds are available, each of them corresponding to a specific objective and perspective.

The EUROHARP project (Kronvang *et al.*, 2009) aimed at providing a broad range of end-users with unbiased guidance for an appropriate choice of model to satisfy existing European requirements on harmonisation, reliability and transparency for quantifying diffuse nutrient losses. It focused on diffuse nutrient losses, nitrogen and phosphorus in particular, from agricultural land to surface freshwater systems and coastal waters, to help end-users implement the Water Framework Directive and the Nitrate Directive. Nine different models were applied to 17 catchments in Europe covering a broad range of climatic, pedologic and farming practices gradients. The models were selected by each participant in the project as one of the official models being used in assessing nutrient losses to surface waters. The models selected included Moneris (Behrendt *et al.*, 2002), Swat (Neitsch *et al.*, 2001) and TRK/ HBV-NP (Brandt and Ejhed, 2002) (see Table 13.2), among others. The models are fully described in Schouman *et al.* (2003) and vary from simple loading functions to complex fully distributed mechanistic models. All models were applied to three core catchments, located in the UK, Italy and Norway, in order to fully investigate the similarities and differences in the various approaches not only in estimating the losses, but also in assessing the contribution of different pathways of losses, nutrient turnover, etc. At least four of the models were applied to each of the 14 remaining catchments in order to test their applicability.

Overall it was concluded that no single model appeared consistently superior in terms of its performance across all three core catchments. Indeed, according to the output variable considered, depending on the goodness of fit of the test used, the models ranked differently on the three core catchments.

The largest variations between model predictions (largest standard deviations) were found for the three Mediterranean catchments mostly due to the limited data availability when

Table 13.2 A summarised description of a sample of models for nutrient transport and retention at the scale of regional watersheds

Model and authors	Geographical resolution	Required input data	Basic equation(s)/principle(s) for nutrient transfer representation	temporal resolution	variables	Watersheds
N-EXPER is over Lepistö <i>et al.</i> , 2001, 2006	Distributed drainage network model (1x1 km grid cells)	Point emissions, distributed land use, drainage network morphology,	N export coefficient by land use class; in-stream and riparian retention parameterised	Annual mean	Total N	All Finnish watersheds
Global-NEWS models Dumont <i>et al.</i> , 2005 Seitzinger <i>et al.</i> , 2009 Mayorga <i>et al.</i> , 2010	Lumped full watershed models	Land use, runoff, lake and reservoirs (dam) area, point emissions (PS) diffuse sources (DS) (fertiliser and manure application, atm. deposition, biological N ₂ fixation, minus N in crops and grass removed from land)	Nutrient outlet load = $\alpha \cdot f(WA, RA, IR) \cdot [DS, \beta \cdot f(Roff) + PS]$ where α and β are calibrated in-stream and watershed retention parameters WA is the watershed area RA is the reservoir (dammed) area IR is the water removed for irrigation Roff is runoff	Annual mean	DIN, DON, PON	All world watersheds
Green Grizzetti <i>et al.</i> , 2005, 2008 Bourouai <i>et al.</i> , 2009	Semi-distributed (lumped by sub-basins)	Land use, rainfall, drainage network morphology (length, lake area), point emissions (PS), diffuse sources (DS) (fertiliser and manure application, atm. deposition, biological N ₂ fixation)	Nutrient outlet load = $\alpha \cdot f(L, Area) \cdot [DS, \beta \cdot f(R) + (PS + UL)]$ where α and β are calibrated in-stream and watershed retention parameters L is the total river length and Area the lake area in the watershed, R is rainfall, UL is the upstream load.	Annual mean	Total N total P	All European basins
(TRK)/HBV-NP Arheimer, 1998 Arheimer <i>et al.</i> , 1998 Bergström <i>et al.</i> , 1987 Brandt, 1990 Pettersson <i>et al.</i> , 2001	Semi-distributed drainage network (HBV-NP) or full watershed (TRK) model (sub-basins divided into elevation zones)	Daily meteorological data, point inputs (P), atmospheric deposition, land-use specific soil-leaching concentrations, potentially produced by a soil model (TRK)	Mechanistic model of N soil dynamics (TRK) Simple calibrated first order, temperature-dependent, in-stream retention parameter (HBV-NP)	Daily	DIN, orgN, totalP	Entire Baltic Sea drainage basin
Moneris Behrendt, 2002	Lumped watershed model	Land use including tile drained areas Runoff divided into several pathways Point emissions (PS) Diffuse sources (DF) defined as soil N surplus	Nutrient outlet load = Σ (for different pathways) $\alpha \cdot f(\text{residence time}) \cdot [DS, + PS]$ where α are <i>a priori</i> calibrated retention parameters	Mean annual	Total N total P	German river basins

Table 13.2 (cont.)

Model and authors	Geographical resolution	Required input data	Basic equation(s)/principle(s) for nutrient transfer representation	temporal resolution	variables	Watersheds
Poiflow De Wit, 2001	Distributed full watershed model (regular grid cells)	Runoff and aquifer residence times, basin topography, soil & aquifer types, Point sources (PS) Diffuse sources (DF) defined as soil N surplus for each grid cell	Nutrient load at grid cell $x = \alpha(\text{slope})_i [DS(x)_i \beta f(s,r) + (PS(x) + UL(x))]$ where α and β are calibrated in-stream and watershed retention parameters In-stream N retention depends on slope and runoff Watershed retention depends on soil type and residence time in aquifers Denitrification in groundwater: regression on residence times and infiltration. UL is the upstream load.	Mean annual	Total N total P	Rhine, Elbe, Norrström
Sparrow Smith <i>et al.</i> , 1997; Preston and Brakebill, 1999; Alexander <i>et al.</i> , 2000, 2001	Semi-distributed full watershed model (sub-basin structure based on monitored reaches)	Basin characteristics (air temperature, precipitation, land-surface slope, soil permeability, stream density, and wetland area) and drainage network characteristics (discharge, time of travel), discharge data Point sources (PS) Diffuse sources (DF) defined as fertilisers and manure application, nonagricultural runoff and atm. deposition	Nutrient load in each reach $x = \alpha(\text{cz, tt})_i [DS(x)_i \beta + (PS(x) + \sum UL(x))]$ where α and β are calibrated in-stream and watershed retention parameters In-stream N retention depends on channel size (cz) and time of travel (tt) (first-order kinetics) Watershed retention depends on basin characteristics. UL is the upstream load.	Mean annual	Total N total P	Major US watersheds
Inca Whitehead <i>et al.</i> , 1998 Wade <i>et al.</i> , 2002a, b	Distributed full watershed model	Daily meteorological and hydrological series, basin characteristics, point inputs, land use, growing seasons of crops, diffuse emissions (included fertilisers and livestock)	Detailed mechanistic approach: * differential equations for describing losses in plant/soil system and instream processes (nitrification, denitrification, sediment dynamics, biological uptake); * reaction rates are calibrated.	Daily	NO ₃ , NH ₄ , total P	A wide range of catchments across Europe
Swat Arnold <i>et al.</i> , 1998, 1999 Neitsch <i>et al.</i> , 2001, 2005	Semi-distributed full watershed model	Meteorological data, topographic slope, soils, land use, nutrient emissions, agricultural management strategies	Mechanistic description of water, nutrient and pesticide routing and transformation in the watershed; mixing equations and simple parametric relationships for drainage network processes	Daily	NO ₃ , NH ₄ , diss&partorgN	Many watersheds in Europe and America
Riverstrahler/Sénéque Billen <i>et al.</i> , 1994 Garnier <i>et al.</i> , 1995, 2002; Ruelland <i>et al.</i> , 2007; Thieu <i>et al.</i> , 2009	Semi-distributed (Riverstrahler) or fully distributed (Sénéque) drainage network model	Meteorological data, drainage network morphology, point emissions, land use, nutrient concentrations of superficial and base flow to streams for each land use class.	Kinetic formulation for each process describing the in-stream dynamics of nutrients; phytoplankton, zooplankton, bacteria (Rive model)	10-Day periods	NO ₃ , NH ₄ , diss&partorg N, P, Si, orgC, phyto/ zooplankton, bacteria	Seine, Somme, Scheldt, Mosel, Danube, Kalix, Lule, Red rivers

Table 13.3 Budget of nitrogen to the basins of a number of rivers as calculated by the MONERIS Model for the 2001–2005 period (Behrendt *et al.*, unpublished data)

kgN/km ² /yr (%)	Danube	Rhine	Weser	Elbe	Odra
Input to land (<i>before landscape retention</i>)	2080	4400	5390	3810	2840
from fertilisers and manure	930	2660	3500	2300	1430
from atmospheric deposition	1150	1740	1890	1510	1410
Landscape retention	1490	3010	4030	2740	2100
diffuse sources (<i>after landscape retention</i>)	590 (70)	1390 (76)	1360 (87)	1070 (78)	740 (80)
background	60	80	70	50	40
from fertilisers and manure	210	670	720	530	360
from atmospheric deposition	330	740	570	490	340
Point sources	250 (30)	450 (24)	210 (13)	310 (22)	190 (20)
Total inputs to hydrosystem	840 (100)	1840 (100)	1570 (100)	1380 (100)	930 (100)
Delivery at outlet	560 (67)	1490 (81)	1300 (83)	920 (67)	400 (43)
In-stream retention	280 (33)	350 (19)	270 (17)	460 (33)	530 (57)

Table 13.4 . Nitrogen budget for three large European watersheds under wet and dry hydrological conditions, calculated by the Riverstrahler model (Trifu-Raducu, 2002; Thieu *et al.*, 2009)

kgN/km ² /yr (%)	Danube		Seine		Scheldt	
	1993 (dry)	1996 (wet)	1996 (dry)	2001 (wet)	1996 (dry)	2001 (wet)
Diffuse sources	966	1079	2012	3905	1227	2837
Point sources	281	281	553	553	1013	1013
Total inputs	1247 (100)	1360 (100)	2566 (100)	4459 (100)	2240 (100)	3850 (100)
Delivery at outlet	474 (38)	667 (49)	1378 (54)	2311 (52)	1213 (54)	2084 (54)
Groundwater storage	—	—	356 (14)	707 (16)	193 (9)	392 (10)
Riparian retention	273 (22)	312 (23)	524 (20)	1161 (26)	607 (27)	1167 (30)
In-stream retention	492 (39)	367 (27)	185 (7)	132 (3)	225 (10)	207 (5)
Reservoir retention	8 (0.6)	14 (1)	13 (0.5)	40 (1)	—	—

compared to the other catchments. Another critical factor affecting model results in these catchments was the model formulation, since in general most models were not developed to cover the Mediterranean regions typically characterised by nonpermanent flow, high rainfall intensity, etc. A similar limitation was found in the Norwegian catchments where none of the models considered frozen soils.

The EUROHARP project highlighted that one of the major sources of discrepancy between the models is the quantification of the retention process. As most models are based on a mass balance approach, in order to accurately quantify the export of nitrogen at the catchment outlet, the models tended to adjust river retention accordingly, resulting in differences in retention estimates larger than one order of magnitude. It is important to note that even if most models did reproduce water and nutrient losses at the outlet reasonably well, the pathways of losses differed considerably between the models. To increase the reliability of the prediction of diffuse losses, it is suggested to scrutinise the internal processes and pathways simulated by the models whenever possible. The overall conclusion was that

the selection of the best model for N loss estimation should be made on a case-by-case basis depending on the catchment type, the purpose of the application, data availability, model limitations, expertise, etc. The parallel use of several models should always be recommended.

13.3.4 Environmental controls of N retention processes

As explained in the above discussion, different models provide different visions of the nature and quantitative importance of retention processes. It is possible, however, to draw a number of general conclusions from the results of various models. Of particular interest in this respect are the results of those models which provide a detailed estimation of different pathways of nitrogen transfer through the watershed and the drainage network, and the corresponding retention. Examples of such results are presented in Tables 13.3 and 13.4, respectively from the Moneris model (a lumped, annual, calibrated model) and the Sénèque model (a distributed, seasonal, mechanistic model).

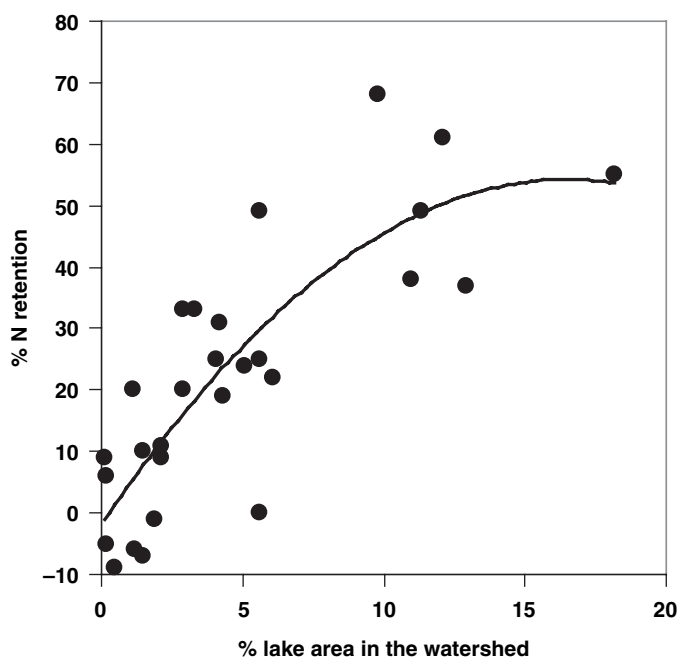

Figure 13.11 In-stream N retention (%) as a function of the percentage lake area in the watershed for 30 Finnish river systems (data from Lepistö *et al.*, 2006).

These models show the significance of processes occurring in the watershed's upper soil layers, in the unsaturated zone and in the riparian wetlands for eliminating or storing nitrogen surplus from agricultural soil. Conversely, tile drainage, which affects agricultural soils in large areas in Europe (including Great Britain, France, the Netherlands, Denmark, Norway, the Baltic countries, Poland and Germany), accelerates nitrogen transfer to surface water.

In-stream retention largely depends on the residence time of water masses through the drainage network and is therefore dependent on both the specific runoff and the presence of lakes and ponds (Figure 13.11).

13.4 N, P and Si delivery from watersheds

13.4.1 The present situation

The level of nitrogen surface water contamination as revealed by the N delivery at the outlet of the major regional watersheds of Europe is depicted in Figure 13.6 above. Delivery rates are at least twice the background value in most of Europe except in the Scandinavian areas, and rates more than ten times the background are not unusual. This reflects a severe level of surface and groundwater contamination, which is described and discussed in Grizzetti *et al.*, 2011 (Chapter 17 this volume).

The total flux of nitrogen delivered to the sea along the EU27 coasts can be estimated at 4.8 TgN/yr of which 4.3 TgN/yr comes from EU27 (4 171 851 km² watershed) and 0.5 TgN/yr from outside EU27 (449 085 km²). This rate of N delivery is nearly five times the estimated natural background (0.98 TgN/yr).

The effect of nitrogen delivery on the coastal zone is highly dependent on the accompanying fluxes of the other nutrients required for the development of marine phytoplankton, particularly phosphorus and silica. For this reason, P and Si delivery rates were also gathered in the database established in the scope of the ENA (Figure 13.12). Table 13.5 summarises the data grouped according to the main coastal marine receiving areas. These are inter-annual average values, and it must be stated again that annual fluxes at the outlet of a regional basin can vary within a factor of two between a dry and a wet hydrological year. Moreover, since not all basins in each coastal zone watershed are documented, missing information has been obtained by extrapolation from nearby documented areas. The figures in Table 13.5 should therefore be considered rough estimates.

13.4.2 The potential for coastal eutrophication (ICEP)

It is now well recognised that the basic cause of coastal eutrophication is related not only to the general nutrient enrichment of the marine system, but also to the imbalance in the delivery of nitrogen (and phosphorus) with respect to silica. Indeed, many authors (Officer and Ryther, 1980; Conley *et al.*, 1993; Conley, 1999; Turner and Rabalais, 1994; Justic *et al.*, 1995; Billen and Garnier, 1997, 2007; Turner *et al.*, 1998; Cugier *et al.*, 2005) have shown that coastal eutrophication is the consequence of excess nitrogen and phosphorus delivery with respect to silica, in relation to the requirements of diatom growth. They underlined that coastal enrichment with nutrients brought in proportion of the Redfield ratios (Redfield *et al.*, 1963), characterising the requirement of diatom growth, seldom causes problems, but, on the contrary, stimulates a healthy and productive food web, as is the case in upwelling areas where new planktonic primary production is mostly ensured by diatoms, while non-siliceous algae are restricted to regenerated production. By contrast, coastal eutrophication problems are the manifestation of *new* production of non-siliceous algae sustained by external inputs of nitrogen and phosphorus brought in excess over silica, thus in conditions where diatom growth is limited. Based on this view of coastal eutrophication, Billen and Garnier (2007) developed an indicator of coastal eutrophication potential (ICEP) of riverine nutrient inputs. This represents the carbon biomass potentially produced in the receiving coastal water body through new production sustained by the flux of nitrogen or phosphorus (depending on which one is limiting with respect to the other) delivered in excess over silica. For the purposes of a river-to-river comparison, it is expressed by unit of watershed area, in kgCkm²/day. It can be calculated by the following relationships (based on the Redfield molar C:N:P:Si ratios 106:16:1:20):

$$\text{N-ICEP} = [\text{NFlx} / (14 \cdot 16) - \text{SiFlx} / (28 \cdot 20)] \cdot 106 \cdot 12$$

if N/P < 16 (*N limiting*)

$$\text{P-ICEP} = [\text{PFlx} / 31 - \text{SiFlx} / (28 \cdot 20)] \cdot 106 \cdot 12$$

if N/P > 16 (*P limiting*)

Figure 13.12 Available observed data on total P (a) and Si (b) delivery by European watersheds (see Figure 13.6 and supplementary material for references).

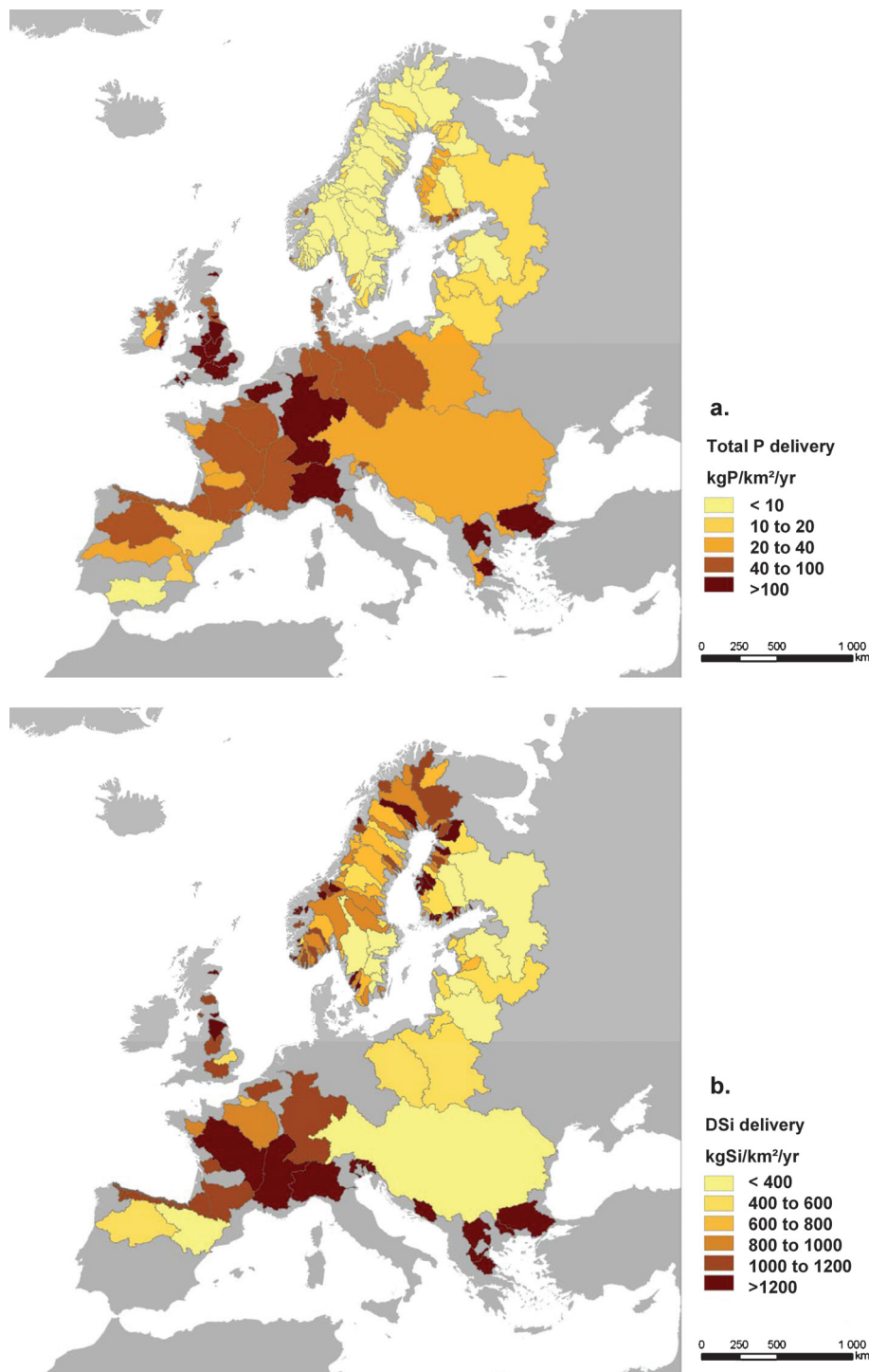

where PFlx, NFlx and SiFlx are, respectively, the mean specific fluxes of total phosphorus, total nitrogen and dissolved silica delivered at the outlet of the river basin, expressed in kgP/km²/day, in kgN/km²/day and in kgSi/km²/day.

A negative ICEP value indicates that silica is present in excess over the limiting nutrient (among nitrogen and phosphorus) and thus characterises the absence of eutrophication problems. Positive values indicate an excess of nitrogen or phosphorus over the potential for diatom growth, thus a condition for harmful non-siliceous algae development. As defined,

the ICEP does not take into account the particular conditions determining the response of the coastal zone into which the river is discharging, but simply represents the potential impact of the riverine fluxes.

According to the N/P ratio of nutrient loading, N or P is the potential limiting nutrient. The ICEP should theoretically be calculated with respect to this nutrient. However, even in the case where P is limiting, a large excess of nitrogen with respect to silica is probably a risk for coastal eutrophication. This is because P is rapidly recycled in the marine environment, so

Table 13.5 Average specific fluxes of N, P and Si delivered by rivers into the different European coastal areas (P and Si flux values in italics and in brackets are educated guesses for undocumented areas). Corresponding Indicator of Coastal Eutrophication Potential (Billen and Garnier, 2007), calculated as the C equivalent of either N (N-ICEP) or P (P-ICEP) brought in excess of Si with respect to the requirements of diatom growth

	Weighted average river loading			ICEP (N)	ICEP (P)	Limitation
	kgN/km ² /yr	kgP/km ² /yr	kgSi/km ² /yr	mgC/km ² /day		
Arctic Ocean						
Norway & Finland Arctic coast	192	3.1	865	-2.4	-5.0	P
NW Norway coast	225	6.0	992	-2.7	-5.5	P
White Sea	244	(4.5)	(900)	-1.8	-5.0	P
Baltic Sea						
SE Sweden Coast	309	7.5	268	3.1	-0.8	P
Bothian Sea	210	10	860	-2.1	-4.2	P
Gulf of Finland	271	12	145	3.3	0.45	P
Gulf of Riga	634	15	434	7.2	-1.0	P
S Baltic and Belt area	698	33	497	7.8	0.6	P
North Sea						
W Norway coast	339	17	1427	-3.6	-7.0	P
Skagerak & Kattegat	509	7.4	644	3.9	-3.2	P
Wadden seas & W Danish coast	2017	136	1158	24	8.1	P
Seine Bight – Belgian coast fringe	2024	93	881	26	5.0	P
E English & Scottish coast	1502	265	1074	17	23	N
Atlantic ocean						
Brittany	2667	21	858	36	-2.9	P
Biscay Bay	1175	62	1429	9.4	-1.9	P
Portuguese & W Spanish coast	623	32	485	6.7	0.6	P
W Scottish, Irish & Welsh coast	1386	73	(1250)	14	0.5	P
S Welsh and English coast	1374	148	(1250)	14	8.9	P
Irish Sea	1758	216	1054	21	18	P
S Spanish coast	988	(30)	(485)	12	0.35	P
Mediterranean Sea						
Lyon Gulf	811	44	815	7.5	-0.11	P
Tyrrhenian Sea	1122	30	800	12	-1.6	P
Central Mediterranean Sea	995	(25)	(800)	10.5	-2.1	P
Ionian Sea	767	21	800	6.9	--2.6	P
Adriatic Sea	1191	92	2130	5.3	-2.9	P
Aegean Sea	530	246	1360	-0.2	19	N
Black Sea						
W Black Sea coast	782	31	267	11.5	1.8	P

that P limitation might not be effective as long as high nitrogen concentrations are available. Moreover, there is evidence that toxin production by non-siliceous as well as siliceous algae is enhanced in high nitrogen concentrations (Murata *et al.*, 2006). An additional reason for considering the N-ICEP even in situations where the N/P ratio is above the Redfield ratio is that excess N not used in a coastal zone is likely to be exported to adjacent areas where it might cause eutrophication problems.

For the European rivers for which N, P and Si loading are documented the (N- and P-) ICEPs have been calculated (Figure 13.13). The mean values extrapolated to all European coastal areas are summarised in Table 13.5.

Figure 13.13 clearly shows that excess N or P delivery with respect to silica is widespread in Europe, with the exception of northern Scandinavia. In most of Europe, nitrogen excess is much more pronounced than phosphorus excess; the reverse is true only in the southern part of the Balkan peninsula,

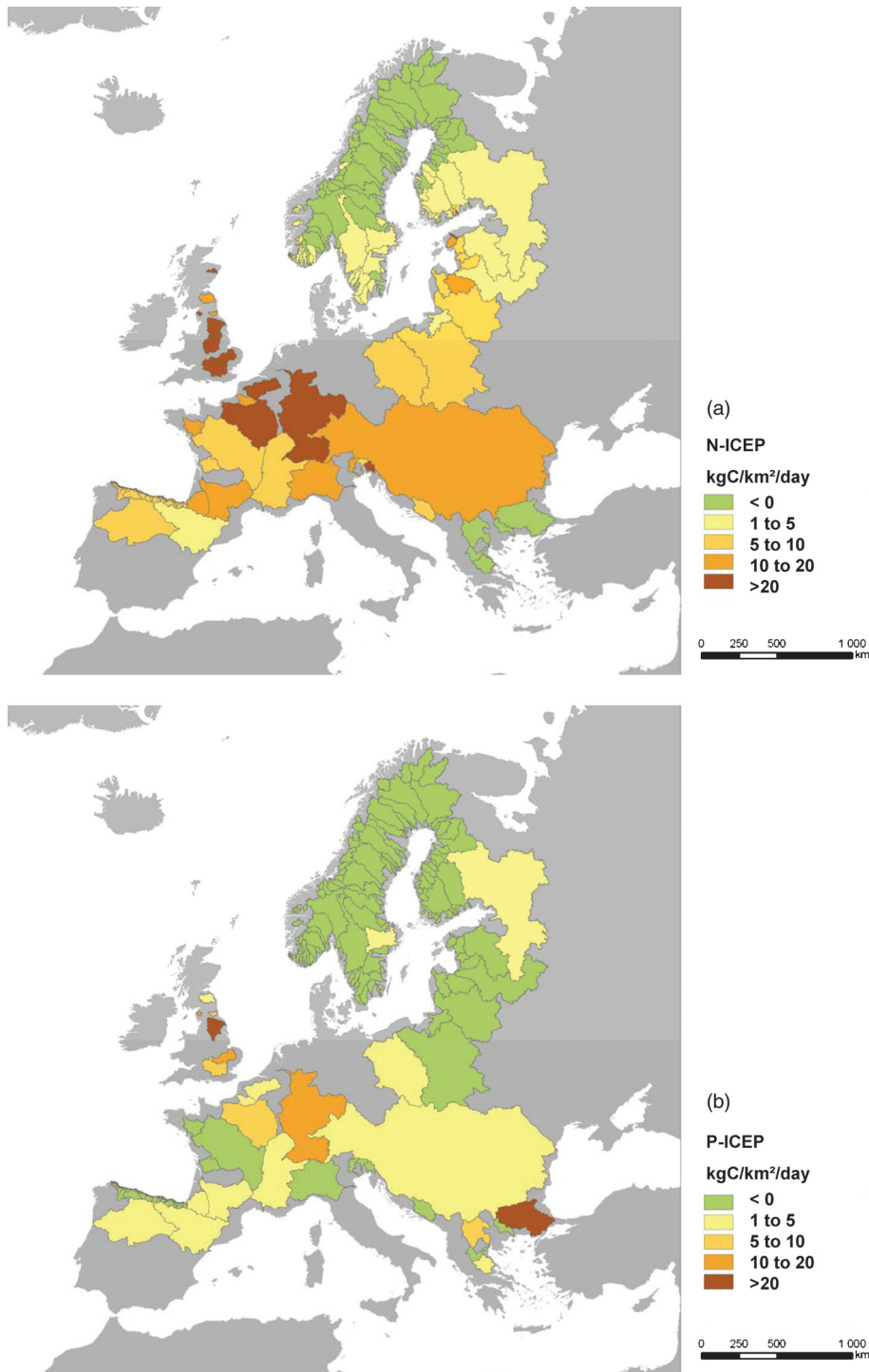

Figure 13.13 Calculated values of N-ICEP (upper panel) and P-ICEP (lower panel) at the outlet of European watersheds.

where specific phosphorus delivery is still very high (see Figure 13.12).

13.4.3 Historical trends

The land- and waterscape of Europe is the heritage of millennia of a complex human history which modified the land cover as well as the river morphology and hydrology. For a number of watersheds, retrospective studies have reconstructed past trends of nutrient inputs, transfer and delivery to the

coastal sea in response to changes in the constraints imposed by human society, using both historical records and modelling approaches (Andersson and Arheimer, 2003, for Swedish rivers; Behrendt *et al.*, 2002, for the Odra and Danube; Billen *et al.*, 2005, for the Scheldt basin; Billen *et al.*, 2007, for the Seine basin; Stalnacke *et al.*, 2003, for Latvian rivers). Such historical studies allow assessing the present degree of perturbation of European watersheds with respect to either pristine or historical situations. They are also particularly useful

to examine the time lag involved in the response of compartments of the system with a very long life time, such as large aquifers and urban structures.

We present here a summary of the general findings of these studies at the European scale.

Reconstituted pristine situations

The pristine level of nitrogen inputs to river systems corresponds to background nitrogen concentration in runoff water from unperturbed forested areas, plus the input of litter from riparian trees. For a hypothetical pristine, entirely forested Seine watershed, Billen *et al.* (2007) estimated this to be 120–300 kgN/km²/yr. The corresponding delivery at the outlet of the drainage network was in the range 60–150 kgN/km²/yr according to hydrological conditions. Similarly, Thieu *et al.* (2010) calculated values in the range 50–250 kgN/km²/yr for the pristine state of the Seine, Somme and Scheldt rivers. These figures are consistent with the value of 228 kgN/km²/yr found above for the y intercept of delivery vs NANI (Figure 13.8, relation (13.1)). They are also close to the values reported for present delivery rates of Swedish and Finnish rivers (see Table 13.1). Spatially representative long-term databases from 42 unmanaged headwater catchments covered by peatlands and forests showed average long-term N export around 130 kgN/km²/yr (site specific range, 29–230 kgN/km²/yr; Kortelainen *et al.*, 2006) and 140 kgN/km²/yr (site specific range, 77–230 kgN/km²/yr; Mattsson *et al.*, 2003).

Corresponding modelled pristine figures for phosphorus and silica delivery from the Seine, Somme and Scheldt basins are in the range of 8–30 kgP/km²/yr and 350–1500 kgSi/km²/yr (Thieu *et al.*, 2010a, b). Observed phosphorus delivery in boreal Finnish rivers is 2–5 kgP/km²/yr. The average long-term P export from unmanaged Finnish catchments was 5.0 kgP/km²/yr (range, 1.7–15 kgP/km²/yr; Kortelainen *et al.*, 2006) and 5.4 kgP/km²/yr (range, 2.1–18 kgP/km²/yr; Mattsson *et al.*, 2003).

Preindustrial agricultural systems

Traditional agricultural practices involved rotation alternating a fallow period and one or two cereal crops, and using manure fertilisation. Estimated nitrogen delivery from landscapes characterised by such agrarian systems varies between 300 and 800 kgN/km²/yr in the Seine basin based on a few available measurements dating back to the nineteenth century (Billen *et al.*, 2007). In an attempt to evaluate the nitrogen delivery from the Seine, Somme and Scheldt basins under a hypothetical scenario with generalised organic farming over their whole agricultural areas, Thieu *et al.* (2010a, b) obtained figures ranging from 430 to 950 kgN/km²/yr depending on the basin and the hydrology.

Phosphorus release from agricultural soils increased significantly with respect to pristine levels because of higher erosion losses. Direct release of phosphorus from point sources from even small cities also leads to increased phosphorus contamination of surface water. For the Seine watershed, the estimated delivery in the periods preceding the twentieth century was in the range of 15–50 kgP/km²/yr.

The question of the role played by agriculture in increasing silica delivery is still under debate. It was generally assumed

that dissolved silica concentration in runoff water, because it originates from rock weathering, only depends on the watershed's lithology. However, some authors stressed the role of vegetation in a terrestrial silica cycle involving active uptake of silica from soil by plants and release of biogenic silica under the form of phytoliths, the dissolution or erosion of which contributes to the inputs of silica from soils to the surface water. Agriculture could therefore have influenced the diffuse sources of silica to river systems (Conley, 2002; Humborg *et al.*, 2004). Rantakari and Kortelainen (2008) demonstrated that in a randomly selected Finnish lake database, SiO₂ had highest correlation coefficient with TIC and CO₂ in lakes surrounded by peatlands, the relation between SiO₂ and inorganic carbon was less close in lakes surrounded by forests or agricultural land, supporting the important role played by biogenic Si cycling. The decomposition of organic matter produces organic acids and carbon dioxide, both of which enhance weathering and thus SiO₂ concentrations.

From 1950 to 1985

In most regions of Europe, the second half of the twentieth century was characterised by both increased urbanisation, often with few wastewater treatment infrastructures, and generalisation of modern agricultural practices with increased use of synthetic fertilisers. In the Seine basin, N delivery peaked in the 1980s at 1500–3000 kgN/km²/yr (according to hydrological conditions). In the Odra river (where low specific discharge is responsible for high retention), Behrendt *et al.* (2005a) calculated an increase from 270 kgN/km²/yr in 1960 to 595 kgN/km²/yr in 1980.

As far as phosphorus is concerned, this period is also characterised by the substitution of traditional soap products by P-containing washing powders, which led to a fourfold increase in the per capita P release rate in urban wastewater. In the Seine basin, delivery rates as high as 350 kgP/km²/yr were reached at the end of 1980. In the Odra River the increase during the 1960–1980 period was from 20 to 50 kgP/km²/yr.

Silica release from domestic wastewater, although not insignificant (Sferratore *et al.*, 2006), is relatively low with respect to the N and P content of urban wastewater. Moreover, eutrophication of surface water, owing to N and P contamination, often resulted in increased retention of dissolved silica related to a more intense diatom development in rivers. Impoundments of large reservoirs also led to increased silica retention either by algae development and trapping of dissolved silica or biogenic particulate silica produced upstream, or by reducing rock weathering in flooded, former wetlands (Humborg *et al.*, 2004, 2006). As a result, the period of industrialisation and urbanisation of the second half of the twentieth century was characterised by a significant decrease in silica delivery, while N and P fluxes increased tremendously.

The economic transition of Eastern countries

The period following the collapse of the former USSR was characterised by major changes in agricultural and industrial activity in all countries of Eastern Europe, resulting in a considerable decrease in fertiliser application and industrial wastewater discharge.

In the Baltic countries (Estonia, Latvia, and Lithuania), formerly specialised in cattle farming, import of mineral fertilisers and feedstuff decreased by a factor of 15 between 1987 and 1996, and the livestock was reduced fourfold, decreasing the use of manure. Yet, this dramatic reduction of the intensity of agriculture led to only a slow and limited response in Latvian rivers' N load, due to the inertia of the soils and aquifer compartments (Stalnacke *et al.*, 2003), while the response in terms of P load was more visible. Similar observations are reported by Behrendt *et al.* (2005a) for the Odra River.

For the Danube basin, although some disagreement exists on its amplitude, a clear decrease of N and P delivery to the Black Sea was reported in the early 1990s (by 9–23% for N, by 25–35% for P), as a result of decreased diffuse sources and point sources (Behrendt *et al.*, 2005b).

The recent trends

During the past 10–15 years, considerable efforts have been devoted to improving surface water quality in most European countries. This resulted in a spectacular decrease of point inputs of nutrients through wastewater discharge. The effect is particularly striking for phosphorus, as improved wastewater treatment was accompanied by the substitution of polyphosphate as a sequestering agent in washing powders, which resulted in a three- to four-fold reduction of the per capita rate of phosphorus release in domestic wastewater. Tertiary treatment of nitrogen in wastewater purification plants is also in progress, particularly in northern European countries.

Diffuse inputs of nutrients by agriculture, however, are still at a high level, in spite of the agro-environmental measures advocated by most European Water Authorities. The inertia of soil and aquifer reservoirs, mentioned above, is here added to the conservatism of many components of the socio-economic agricultural sphere.

As a result, phosphorus delivery is rapidly decreasing at the outlet of most European rivers, while nitrogen delivery is still increasing or at best levelling off (Figure 13.14).

13.5 The estuarine filter

13.5.1 Typology of European estuaries

Before reaching the sea, the flux of nutrients delivered at river outlets has to cross their estuarine zones, which are often biogeochemically very active systems. The different coastal systems of Europe, however, offer a wide range of estuarine types, differing in their filtering effect for riverine nutrients. Meybeck and Dürr (2009) have proposed a typology of estuaries, based on coastal morphology, tidal influence and freshwater discharge, distinguishing (i) fjords and fjärds (deep glacial valleys filled with marine water, but where snow melt leads to rapid transit of surface freshwater to the coastal zone), (ii) rias (drowned river valleys, dominated by seawater dynamics), (iii) macrotidal estuaries (where the tidal circulation gives rise to the development of a turbidity maximum zone), (iv) deltas (prograding wedges of sediment at the river mouth with restricted entrance of seawater) and (v) lagoons (littoral shallow brackish

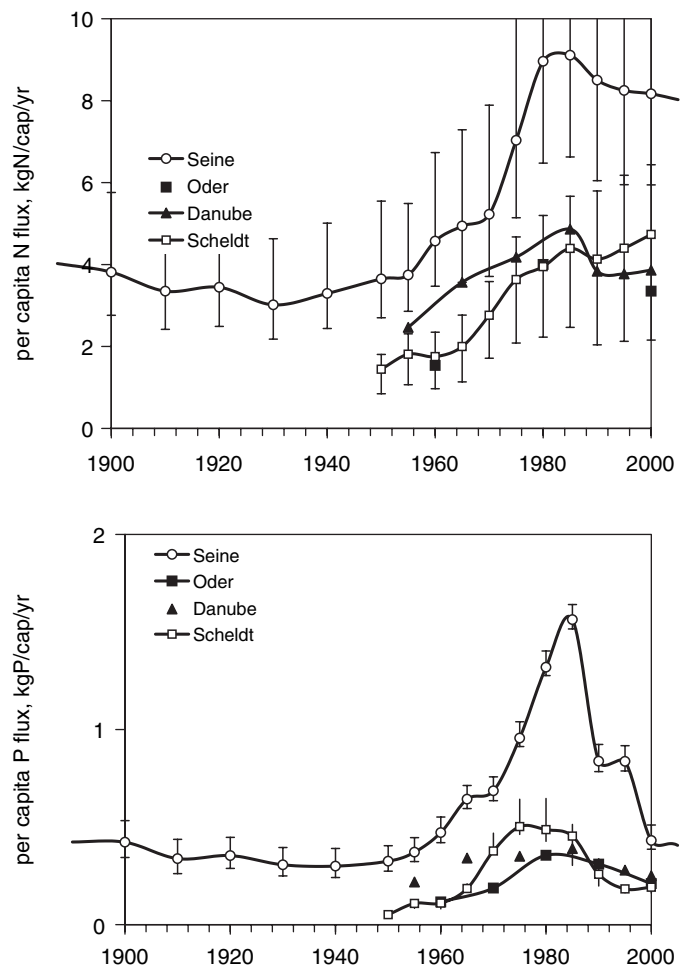

Figure 13.14 Trends of N and P delivery for different European rivers during the twentieth century, normalised to the total population of the watershed. Data are a combination of observations and a model reconstruction from Billen *et al.*, 2005, 2007 (the Scheldt and the Seine), Behrendt *et al.*, 2002, 2005a,b (the Oder and the Danube). For the Seine and Scheldt, the error bars show the values for wet and dry hydrological conditions, while the other values refer to mean hydrological conditions.

ponds with permanent or temporary sea water exchange). Karstic areas are characterised by direct inputs of groundwater to the sea. Figure 13.15 shows the dominant types of estuaries along the coasts of Europe.

13.5.2 Estuarine nutrient retention

Estuarine nutrient processing is highly varied and too few studies are available to make any generalising quantitative statement on the filtering effect of estuaries on riverine nutrient fluxes. Figure 13.16 summarises a number of European case studies where the retention of the land-based nitrogen loading during the transit through the estuarine zones has been evaluated. These studies highlight the effect of residence time on overall retention. Nixon *et al.* (1996) proposed a relationship similar to that proposed by Kelly *et al.* (1987) for lakes, relating N retention during estuarine transit to depth and residence time; this relationship fits generally well with the data assembled for European estuaries (Figure 13.16).

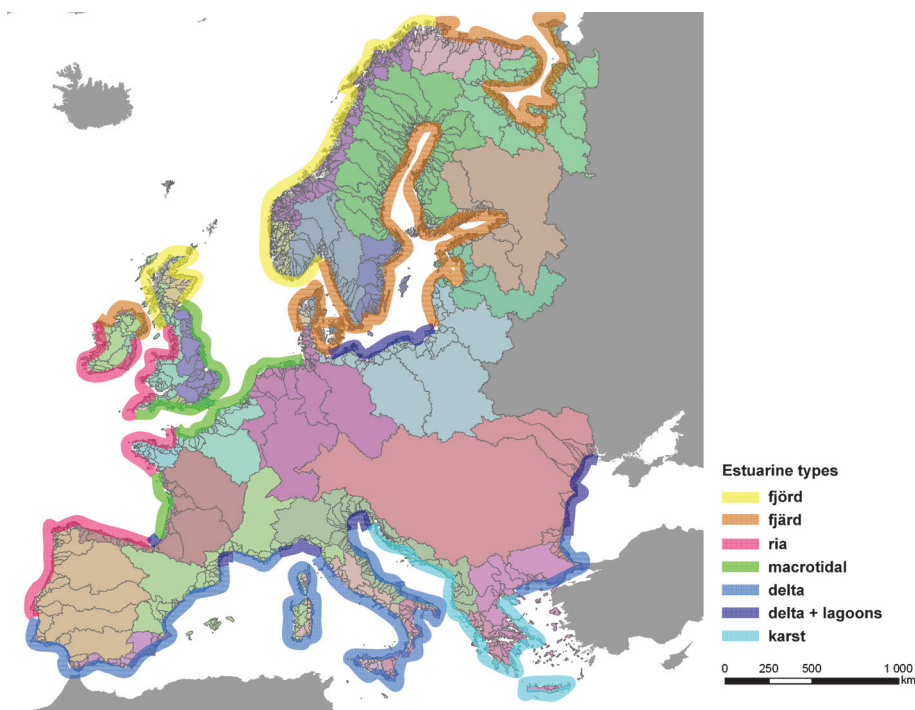

Figure 13.15 Dominant types of estuaries along Europe's coastlines (Meybeck and Dürr, 2009).

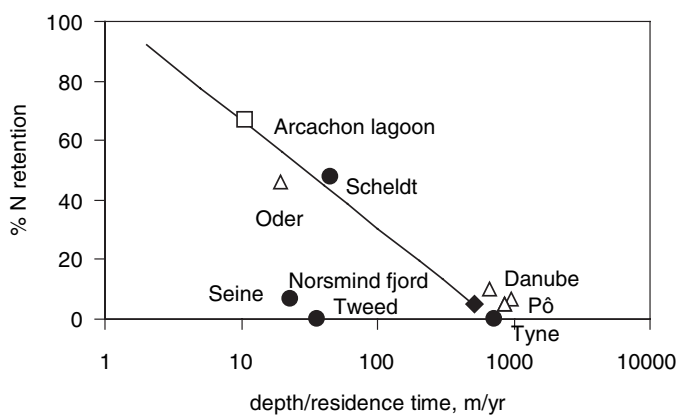

Figure 13.16 Observed N retention during transit through some European estuaries, plotted *versus* the depth/residence time ratio. The line represents the relationship found by Nixon *et al.* (1996) for a number of North Atlantic American estuaries. European case studies include deltas [the Danube (Trifu-Raducu, 2002); the Po (De Wit and Bendoricchio, 2001), the Rhone (Pettine *et al.*, 1998; El-Habr and Golterman, 1987), the Oder (Pastuszak *et al.*, 2005)], macrotidal estuaries (Seine (Garnier *et al.*, 2010), the Scheldt (Billen *et al.*, 1985), the Tyne and Tweed (Ahad *et al.*, 2006)), a fjord (Norsminde fjord (Nielsen *et al.*, 1995) and a lagoon Arcachon lagoon, DeWit *et al.*, 2005).

Those estuarine systems where substantial nitrogen processing is occurring, including nitrification and denitrification, are often characterised by N_2O concentrations far above saturation, indicating that they act as a source for this greenhouse gas. This has been observed in the Tamar (Law *et al.*, 1992), the Humber (Barnes and Owens, 1998), the Scheldt (de Wilde and de Bie, 2000), and the Seine (Garnier *et al.*, 2006) estuaries, where emission rates ranged from 0.4 to 5 $gN-N_2O/m^2/yr$. In the case of the Tyne estuary where high ammonium release occurs in the rapidly flushed estuarine zone, an area of high N_2O emission is observed in the adjacent coastal zone (Ahad *et al.*, 2006).

13.6 Nitrogen delivery and coastal eutrophication

13.6.1 Coastal eutrophication in European coastal waters

Riverine delivery considerably affects (positively or negatively) the ecological functioning of coastal marine ecosystems, as it most often represents the major source of new nutrients for primary production.

Satellite determination of coastal marine algal biomass have been available since the early 2000s, based on the radiometric observation of changes of seawater colour from blue to green as the chlorophyll concentration increases. A composite image of chlorophyll distribution in European coastal zones is shown as an example in Figure 13.17. The conversion of the optical signal to *in situ* pigment concentration relies on the calibration of algorithms which are highly dependent on the presence of various organic and inorganic constituents of seawater and can lead to severe overestimation of actual biomass (Darecki and Stramski, 2004). Qualitatively, however, Figure 13.17 clearly shows the effect of riverine nutrient discharge on algal biomass distribution in European coastal zones.

In and of itself, this enhancement of primary producer biomass would not be a problem, if it were not often accompanied by profound changes in the structure of the food webs and a decline of zooplankton grazing and commercial fish production (Vasas *et al.*, 2007), as well as by diverse harmful manifestations such as organic matter accumulation, toxin production, anoxia, etc. A detailed account of the problems related to coastal eutrophication is provided by Voss *et al.* (2011, Chapter 8, this volume).

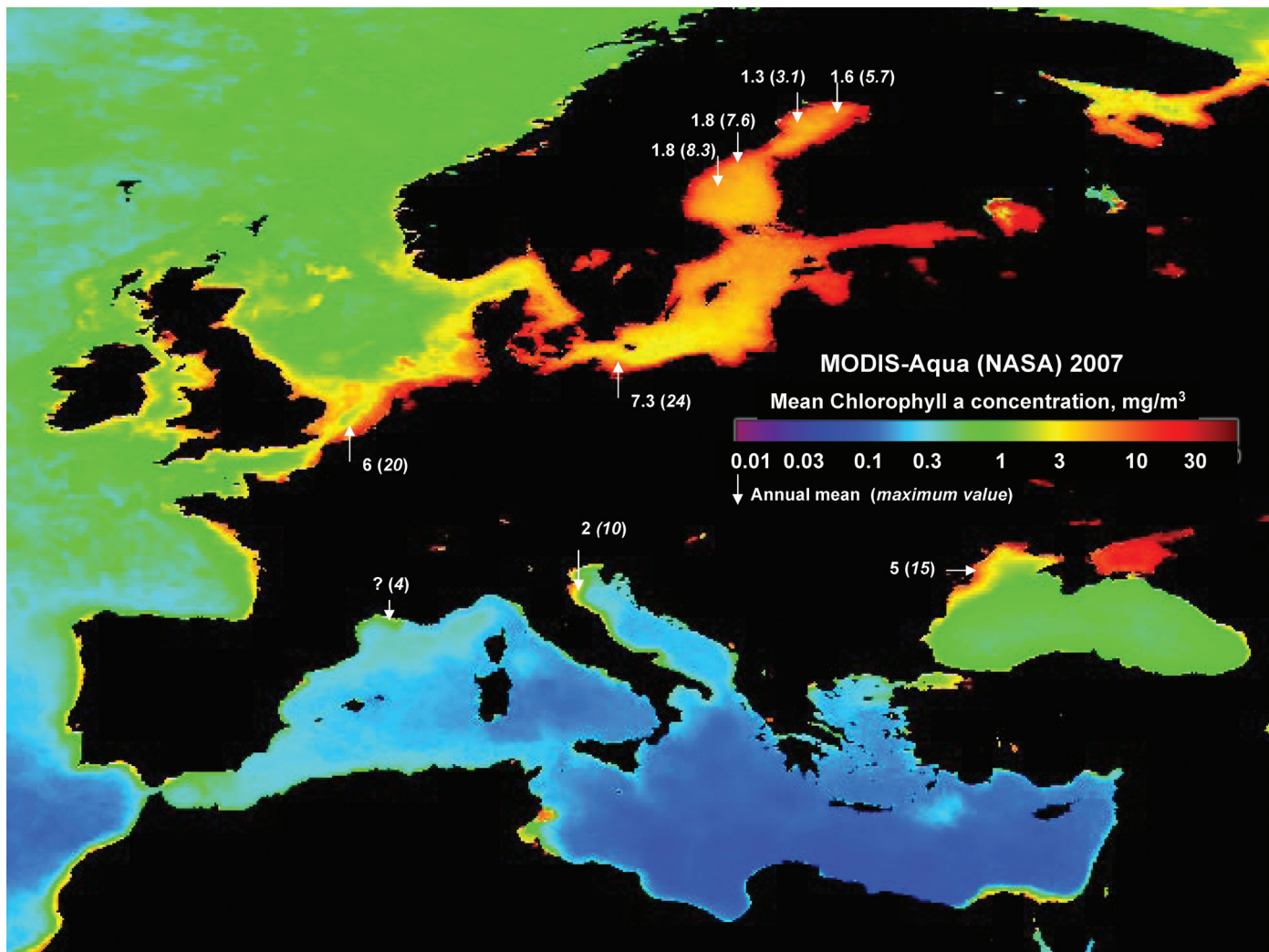

Figure 13.17 Composite satellite image of mean chlorophyll concentration along the European coasts in 2007 (from MODIS-Aqua satellite data, source: JRC, <http://marine.jrc.ec.europa.eu/>). Annual mean and maximum values in brackets of direct measurements at selected stations are also shown to provide an absolute reference (Lancelot *et al.*, 2005; Solidoro *et al.*, 2009; M. Voss, personal communication).

13.6.2 Comparing indicators and observation of coastal eutrophication

Ignoring the role played by the estuarine filter on riverine nutrient delivery, the data gathered in Table 13.5 can be compared with the available observations of coastal eutrophication along European coastlines (Figure 13.18).

On the basis of the N/P ratio of nutrient river loading calculated in Table 13.5, phosphorus presently appears as the potentially limiting nutrient in most coastal areas, except in the Aegean Sea, where phosphorus loading is still extremely high. This situation is recent and contrasts with that of the 1980s when, owing to much higher P loading, nitrogen was likely to be the limiting nutrient in most European coastal areas (see Section 13.4.3 and Figure 13.14). Note that the Gulf of Finland, as well as many other areas of the Baltic Sea, are still regarded as N-limited for most of the growth period (Graneli *et al.*, 1990; Tamminen and Andersen, 2007). P limitation increases towards the north in the Gulf of Bothnia (Tamminen and Andersen, 2007). Admittedly,

the N/P calculation based on riverine deliveries does not take into account the effect of the biogeochemical processes in receiving coastal waters (sedimentation, denitrification, sediment release). Thus, in the Baltic Sea these processes tend to shift the ratios from estuarine P towards N limitation in the open sea (Pitkänen and Tamminen, 1995; Tamminen and Andersen, 2007).

The ICEP shows negative values (whether it is estimated on the basis of N or P) in the Arctic coastal zones as well as in the northern Baltic. Positive ICEP values are reached in the southern Baltic, as well as in the North Sea and along most Atlantic coasts. In the Mediterranean, positive ICEP values are observed in rivers flowing into the Adriatic and Tyrrhenian seas. The western Black Sea coast is also characterised by high ICEP values.

The distribution of European coastal areas designated as subject to the risk of eutrophication in the discussion above fits well with the observations of eutrophication problems, although the manifestations of eutrophication might be quite different depending on the local physiographical and hydrological

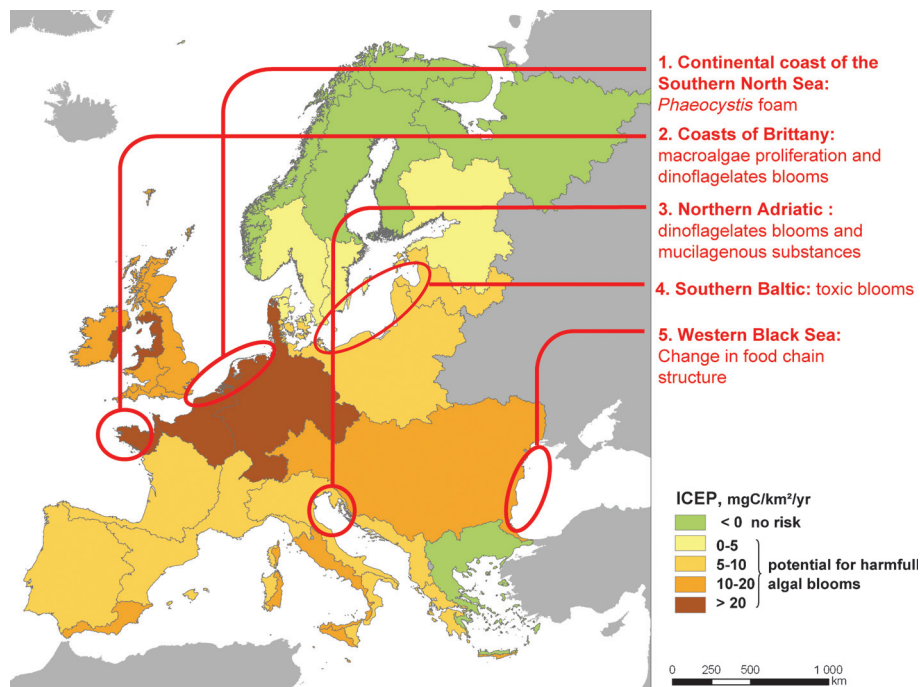

Figure 13.18 Calculated Indicator of Coastal Eutrophication Potential (ICEP) by European coastal region, based on the data from Table 13.5. Identification of the major coastal areas where eutrophication problems are recorded.

conditions: blooms of toxic algae, as in the Seine Bight (Cugier *et al.*, 2005) and in the Baltic (Hansson, 2008; HELCOM, 2009), massive development of mucilaginous, unpalatable, algal species in the North Sea (Lancelot *et al.*, 1987, 2005, 2007), the Black Sea (Cociasu *et al.*, 1996) and the Adriatic Sea (Marchetti, 1991), deposition of increasing amounts of organic material resulting in anoxic bottom waters as in the northern Adriatic (Justic, 1991), Danish coastal waters (Babenerd, 1990) and Baltic coastal zones (HELCOM, 2009).

In *Brittany and on the other Atlantic coasts*, the very rapid dilution of fresh water masses due to tidal currents often prevents the development of dense planktonic blooms. Eutrophication is mainly apparent from the development of benthic macro algae close to the coast, although development of toxic dinoflagellate blooms might also be a problem during summer when the water column is stratified.

The *continental coastal zone of the English Channel and the North Sea*, from Normandy to the Danish coast, is one of the more severely eutrophicated areas in the world, with the occurrence of heavy blooms of *Phaeocystis globosa* colonies every spring, responsible for the accumulation of mucus foam on the beaches (Lancelot, 1995). Marine ecological model simulations constrained by river nutrient load simulations suggest that the maximum biomass reached by *Phaeocystis* increased three-fold from 1950 to 1990 and has now decreased by about 20% (Lancelot *et al.*, 2007).

The *Baltic Sea* is a nearly enclosed brackish-water area, with seawater renewal occurring through the narrow Danish Straits and Sound areas linking the Baltic to the North Sea. Major inflows of seawater have only occurred rarely in recent decades, leaving the water in the deeper basins without a renewal of oxygen. Salinity stratification, small water volume and long residence time are the main physical reasons for the

sensitivity of the Baltic Sea to eutrophication (Leppäranta and Myrberg, 2009). The sea is heavily impacted by nutrient loading and anoxic conditions promoting release of inorganic phosphorus from the sediments (Pitkänen *et al.*, 2001). The impacts of eutrophication are manifested as various symptoms such as increased nutrient concentrations and phytoplankton biomass, oxygen deficiency and elimination of benthic fauna, as well as frequent blooms of filamentous cyanobacteria (Lundberg, 2005).

The *northwestern Adriatic Sea*, subject to the inputs of the Po River, also suffers from the development of non-siliceous algae leading to the production of mucilaginous substances. Detection of organic-walled dinoflagellate on sediment cores revealed a clear shift to eutrophication conditions from 1930 onwards, reaching a peak in the 1960–1980 period. Subsequently, eutrophication levels decreased, although dinocyst diversity suggests that the ecosystem has not completely recovered (Sangiorgi and Donders, 2004).

The *western coast of the Black Sea* has been experiencing a severe process of degradation since the early 1960s. From a diverse ecosystem with rich ecological resources, it evolved into a low biodiversity zone where jellyfish and ctenophores replaced zooplankton–fish food chains. An almost total collapse of fisheries occurred in the late 1980s (Mee, 1992; Lancelot *et al.*, 2002). The considerably reduced Danube nutrient discharge over the past 15 years, following the collapse of industry and agriculture in the former Soviet countries of the Danube catchment area, however, induced a trend towards restoration of the marine ecosystem. The species diversity of macrozoobenthos has increased since 1996 in front of the Danube delta (Horstmann *et al.*, 2003), but ctenophores and medusa still dominate the zooplankton, preventing the full regeneration of fish populations.

13.7 Conclusions

Urbanisation and the spread of industrial fertilisation techniques in agriculture in most European territories have led to an unprecedented opening of the nitrogen cycle which resulted in increased inputs of reactive nitrogen to watersheds. Compared with the background pristine inputs of N through natural biological fixation and atmospheric deposition (460–1800 ktonN/yr, based on the figures compiled by Cleveland, 1999), net anthropogenic inputs of reactive nitrogen to EU27 (21 540 ktonN/yr) are two to ten times higher.

A fraction of only about 20% of these inputs ultimately reaches the outlet of the hydrographic network of large river systems, while both landscape and aquatic processes contribute to retention of the remaining 80% of anthropogenic inputs. Landscape processes include storage of nitrogen in the soil organic matter pool and in the groundwater. This is temporary storage, which simply confers a great inertia of the response of riverine delivery to changes in diffuse inputs: depending on the residence time of nitrogen in these reservoirs, the reaction to any change in land use and agricultural practices in terms of nitrogen flux at the basin outlet can be delayed by several decades. Soil and riparian zone denitrification are other processes contributing substantially to landscape retention; the elimination of nitrate by this pathway unfortunately is accompanied by harmful emissions of N₂O. In-stream nitrogen retention processes are dominated by benthic denitrification both in the river bed and in small water storage structures such as ponds and shallow reservoirs. This process also leads to N₂O emissions, however. The relative role played by lakes in terms of N retention within watersheds is important: two major processes involved are denitrification and sedimentation. Wastewater treatment must be considered a retention process when it involves specific processes for N elimination, most often through denitrification, accompanied, once again, by N₂O emissions.

In spite of these effective retention mechanisms, many of which can still be improved by suitable management, nitrogen delivery to coastal systems at the European scale, now totalling 4750 ktonN/yr, increased more than fourfold with respect to the pristine state, and approximately threefold with respect to the pre-1950 situation.

At the same time, phosphorus delivery increased, but is now decreasing again close to preindustrial levels, owing to effective P abatement measures in urban wastewater purification implemented in most European countries. Silica delivery, on the other hand, is decreasing due to both reduced rock weathering and enhanced retention in watersheds, mostly linked to dam construction (Humborg *et al.*, 2008).

The consequence of these changes is that the riverine input of nutrients to the coastal zones, which used to be a major factor contributing to the richness of these areas providing most of the fish catch, is now largely imbalanced, resulting in severe eutrophication problems. Particularly affected are the south-eastern continental coast of the North Sea, the Baltic Sea (except the Gulf of Bothnia), the coasts of Brittany, the Adriatic Sea and the western Black Sea coastal area.

Better knowledge and understanding of the processes leading to retention and elimination of reactive nitrogen once introduced within watersheds would certainly allow better management of land- and waterscapes with the objective of reducing the N fluxes transferred to the sea and to the atmosphere as reactive species. However, whatever the potential of such management measures, there will be no other choice for durably improving the situation than reducing the anthropogenic nitrogen load, through changes in agriculture, human diet and other nitrogen flows related to modern human activity.

Acknowledgements

This chapter was prepared with the support of the NinE Programme of the European Science Foundation, the NitroEurope IP (funded by the European Commission) and the COST Action 729. It grew from the discussions held in two workshops held in Paris in January 2007 (with the support of both NinE and LOICZ) and in Dourdan in November 2008 (with the support of NinE and COST729). It also benefited from the participation in other collaborative networks including TIMOTHY Interuniversity Attracting Pole of the Belgian Science Policy and the AWARE EC-FP7 programme.

We acknowledge Amelie Danacq for establishing Table 13.2. We also acknowledge Hast Behrendt for his active participation in this workshops mentioned above; he has since passed away. We dedicate this chapter to his memory.

Supplementary materials

Supplementary materials (as referenced in the chapter) are available online through both Cambridge University Press: www.cambridge.org/ena and the Nitrogen in Europe website: www.nine-esf.org/ena.

References

- Ahad, J. M. E., Ganeshram R. S., Spencer, R. G. M. *et al.* (2006). Evaluating the sources and fate of anthropogenic dissolved inorganic nitrogen (DIN) in two contrasting North Sea estuaries. *Science of the Total Environment*, **372**, 317–333.
- Alexander, R. B., Smith, R. A. and Swartz, G. E. (2000). Effect of stream channel size on the delivery of nitrogen to the Gulf of Mexico. *Nature* **403**, 758–761.
- Alexander, R. B., Smith, R. A., Schwarz, G. E. *et al.* (2001). Atmospheric nitrogen flux from the watersheds of major estuaries of the United States: an application of the SPARROW watershed model. In: *Nitrogen Loading in Coastal Water Bodies: An Atmospheric Perspective*, ed. R. Valigura, R. Alexander, M. Castro, *et al.* American Geophysical Union, Madison, WI, pp. 119–170.
- Alexander, R. B., Johnes, P. J., Boyer, E. W. and Smith, R. A. (2002). A comparison of models for estimating the riverine export of nitrogen from large watersheds. *Biogeochemistry*, **2002**, 295–339.
- Andersson, L. and Arheimer, B. (2003). Modelling of human and climatic impact on nitrogen load in a Swedish river 1885–1994. *Hydrobiologia*, **497**, 63–77.
- Arheimer, B. (1998). Riverine nitrogen – analysis and modelling under nordic Conditions. Ph.D. Thesis. Linköping University, Sweden.
- Arheimer, B. and Brandt, M. (1998). Modelling nitrogen transport and retention in the catchments of southern Sweden. *Ambio*, **27**, 471–480.

- Arnold, J. G., Srinivasan, R., Muttiah, R. S. and Williams, J. R. (1998). Large area hydrologic modeling and assessment. Part I: Model development. *Journal of the American Water Resources Association*, **34**, 73–89.
- Arnold, J. G., Srinivasan, R., Muttiah, R. S., Allen, P. M. and Walker, C. (1999). Continental scale simulation of the hydrologic balance. *Journal of the American Water Resources Association*, **35**, 1037–1052.
- Babenerd, B. (1990). Eutrophication and algal blooms. *Water Pollution Research Reports*, **12**, 215–223.
- Barnes, J. and Owens, N. J. P. (1998). Denitrification and nitrous oxide concentrations in the Humber Estuary, UK, and adjacent coastal zones. *Marine Pollution Bulletin*, **37**, 247–260.
- Behrendt, H. (2002) *The Model System MONERIS*. EUROCAT WD.
- Behrendt, H. and Opitz, D. (2000). Retention of nutrients in river systems: dependence on specific runoff and hydraulic load. *Hydrobiologia*, **410**, 111–112.
- Behrendt, H., Huber, P., Kornmilch, M. *et al.* (2002). Estimation of the nutrient inputs into river basins: experiences from German rivers, *Regional Environmental Changes*, **3**, 107–117.
- Behrendt, H., Opitz, D., Korol, R. and Stronszka, M. (2005a). Changes of the nutrient loads of the Odra River during the last century: their causes and consequences. In: *Proceedings of the ICID 21st European Regional Conference 'Integrated Land and Water Management: Towards Sustainable Rural Development'*, Frankfurt/Oder, Germany, April 2005.
- Behrendt, H., van Gils, J., Schreiber, H. and Zessner, M. (2005b). Point and diffuse nutrient emissions and loads in the transboundary Danube River Basin. Part II: Long term changes. *Archives of Hydrobiology (Suppl.)*, **158**, 221–247.
- Bergström, S., Brandt, M. and Gustafson, A. (1987). Simulation of runoff and nitrogen leaching from two fields in southern Sweden. *Hydrological Science Journal*, **32**, 191–205.
- Billen, G. and Garnier, J. (1997). The Phison River Plume: coastal eutrophication in response to changes in land use and water management in the watershed. *Aquatic Microbiology and Ecology*, **13**, 3–17.
- Billen, G. and Garnier, J. (2007). River basin nutrient delivery to the coastal sea: assessing its potential to sustain new production of non siliceous algae. *Marine Chemistry*, **106**, 148–160.
- Billen, G., Somville, M., De Becker, E. and Servais, P. (1985). A nitrogen budget of the Scheldt hydrographical basin. *Netherlands Journal of Sea Research*, **19**, 223–230.
- Billen, G., Garnier, J. and Hanset, P. (1994). Modelling phytoplankton development in whole drainage networks: the RIVERSTRAHLER model applied to the Seine river system. *Hydrobiologia*, **289**, 119–137.
- Billen, G., Garnier, J. and Rousseau, V. (2005). Nutrient fluxes and water quality in the drainage network of the Scheldt basin over the last 50 years. *Hydrobiologia*, **540**, 47–67.
- Billen, G., Garnier, J., Némery, J. *et al.* (2007). Nutrient transfers through the Seine river continuum: mechanisms and long term trends. *Science of the Total Environment*, **375**, 80–97.
- Billen, G., Barles, S., Garnier, J., Rouillard, J. and Benoit, P. (2009a). The food-print of Paris: long term reconstruction of the nitrogen flows imported to the city from its rural hinterland. *Regional Environmental Change*, **9**, 13–24.
- Billen, G., Thieu, V., Garnier, J. and Silvestre, M. (2009b). Modelling the N cascade in regional watersheds: the case study of the Seine, Somme and Scheldt rivers. *Agriculture, Ecosystems and Environment*, **133**, 234–246.
- Billen, G., Beusen, A., Bouwman, L. and Garnier J. (2010). Anthropogenic nitrogen autotrophy and heterotrophy of the world's watersheds: past, present, and future trends. *Global Biogeochemical Cycles*, **24**, GB0A11, doi:10.1029/2009GB003702.
- Boyer, E. W., Goodale, C. L., Jaworski, N. A. and Howarth, R. W. (2002). Anthropogenic nitrogen sources and relationships to riverine nitrogen export in the northeastern USA. *Biogeochemistry*, **57/58**, 137–169.
- Brandt, M. (1990). Simulation of runoff and nitrogen transport from mixed basins in Sweden. *Nordic Hydrology*, **21**, 13–34.
- Brandt, M. and Ejhed, H. (2002). *TRK, Transport-Retention-Källfördelning, Belastning Pahavet*, Swedish Environment Protection Agency, Report 5247, Stockholm, Sweden, 2002, (in Swedish).
- Brunet, R. (2002). Lignes de force de l'espace Européen. *Mappemonde*, **66**, 14–19.
- Cellier, P., Durand, P., Hutchings, N. *et al.* (2011). Nitrogen flows and fate in rural landscapes. In: *The European Nitrogen Assessment*, ed. M. A. Sutton, C. M. Howard, J. W. Erisman *et al.*, Cambridge University Press.
- Cleveland, C. C., Townsend, A. R., Schimel, D. S. *et al.* (1999). Global patterns of terrestrial biological nitrogen fixation in natural ecosystems. *Global Biogeochemical Cycles*, **13**, 623–645.
- Cociasu, A., Dorogan, L., Humborg, C. and Popa, L. (1996). Long-term ecological changes in Romanian coastal waters of the Black Sea. *Marine Pollution Bulletin*, **32**, 32–38.
- Conley, D. J. (1999). Biogeochemical nutrient cycles and nutrient management strategies. *Hydrobiologia*, **289**, 87–96.
- Conley, D. J. (2002). Terrestrial ecosystems and the global biogeochemical silica cycle. *Global Biogeochemical Cycles*, **16**, 1121, doi: 10.1029/2002GB001894.
- Conley, D. J., Schelske, C. L. and Stoermer, E. F. (1993). Modification of the biogeochemical cycle of silica with eutrophication. *Marine Ecology Progress Series*, **81**, 121–128.
- Cugier, P., Billen, G., Guillaud, J. F., Garnier, J. and Ménesguen, A. (2005). Modelling eutrophication of the Seine Bight under present, historical and future Seine river nutrient loads. *Journal of Hydrology*, **304**, 381–396.
- Darecki, M. and Stramski, D. (2004). An evaluation of MODIS and SeaWiFS bio-optical algorithms in the Baltic Sea. *Remote Sensing of the Environment*, **89**, 326–350.
- de Wilde, H. P. J. and de Bie, M. J. M. (2000). Nitrous oxide in the Schelde estuary: production by nitrification and emission to the atmosphere. *Marine Chemistry*, **69**, 203–216.
- De Wit, M. (2001). Nutrient fluxes at the river basins scale. Part I: The PolFlow model. *Hydrological Processes*, **15**, 743–759.
- De Wit, M. and Bendoricchio, G. (2001). Nutrient fluxes in the Po basin. *Science of the Total Environment*, **273**, 147–161.
- De Wit, R., Leibreich, J., Vernier F. *et al.* (2005). Relationship between land-use in the agro-forestry system of les Landes, nitrogen loading to and risk of macro-algal blooming in the Bassin d'Arcachon coastal lagoon (SW France). *Estuarine, Coastal and Shelf Science*, **62**, 453–465.
- Dillon, P. J., Evans, R. D. and Molot, L. A. (1990). Retention and resuspension of phosphorus, nitrogen, and iron in a central Ontario lake. *Canadian Journal of Aquatic Science*, **47**, 1269–1274.
- Dumont, E., Harrison, A., Kroeze, C., Bakker, E. J. and Seitzinger, S. P. (2005). Global distribution and sources of dissolved inorganic nitrogen export to the coastal zone: result from a spatially explicit, global model. *Global Biogeochemical Cycles* **19**, GB4S02, doi:10.1029/2005 GB002488
- Durand, P., Breuer, L. and Johnes, P. J. (2011). Nitrogen turnover processes and effects in aquatic ecosystems. In: *The European Nitrogen Assessment*, ed. M., Sutton, C., Howard, J.W. Erisman, *et al.* Cambridge University Press.

- El-Habr, H. and Golterman, H. L. (1987). Input of nutrients and suspended matter into the Golfe du Lion by the river Rhone? *Chemosphere*, **16**, 417–418.
- Garnier, J., Billen, G. and Coste, M. (1995). Seasonal succession of diatoms and chlorophyceae in the drainage network of the River Seine: *observations and modelling*. *Limnology and Oceanography*, **40**, 750–765.
- Garnier, J., Billen, G., Hannon, E. *et al.* (2002). Modeling transfer and retention of nutrients in the drainage network of the Danube River. *Estuarine and Coastal Shelf Science*, **54**, 285–308.
- Garnier, J., Cébron, A., Tallec, G. *et al.* (2006). Nitrogen behaviour and nitrous oxide emission in the tidal Seine River estuary (France) as influenced by human activities in the upstream watershed. *Biogeochemistry*, **77**, 305–326.
- Garnier, J., Billen, G., Némery, J. and Sebilo, M. (2010). Transformations of nutrients (N, P, Si) in the turbidity maximum zone of the Seine estuary and export to the sea. *Estuarine and Coastal Shelf Science* (in press).
- Graneli, E., Wallström, K., Larsson, U., Graneli, W. and Elmgren, R. (1990). Nutrient limitation of primary production in the Baltic Sea area. *Ambio*, **19**, 142–151.
- Grizzetti, B. and Bouraoui, F. (2006). *Assessment of Nitrogen and Phosphorus Environmental Pressure at European Scale*. European Commission, Joint Research Centre, Luxembourg.
- Grizzetti, B., Bouraoui, F., de Marsily, G. and Bidoglio, G. (2005). A statistical approach to estimate nitrogen sectorial contribution to total load. *Water Science and Technology*, **51**, 83–90.
- Grizzetti, B., Bouraoui, F. and De Marsily, G. (2008). Assessing nitrogen pressures on European surface water, *Global Biogeochemical Cycles*, doi:10.1029/2007GB003085.
- Grizzetti, B., Bouraoui, F., Billen, G. *et al.* (2011). Nitrogen as a threat to European water quality. In: *The European Nitrogen Assessment*, ed. M. A. Sutton, C. M. Howard, J. W. Erisman *et al.*, Cambridge University Press.
- Hansson, M. (2008). Cyanobacterial blooms in the Baltic Sea. HELCOM Indicator Fact Sheets 2008. Available online: http://www.helcom.fi/environment2/ifs/ifs2008/en_GB/cyanobacteriaBlooms/ [Viewed 24 March 2009]
- HELCOM (2009). *Eutrophication in the Baltic Sea: An Integrated Thematic Assessment of the Effects of Nutrient Enrichment in the Baltic Sea Region*. HELCOM, Helsinki.
- Horstmann, U., Davidov, A., Cociasu, A. and Velikova, V. (2003). Der Einfluss verringerter Nährstofffrachten der Donau auf das Schwarze Meer. *Österreichische Wasser- und Abfallwirtschaft*, **55**, 205–212.
- Howarth, R. W., Billen, G., Swaney, D. *et al.* (1996). Regional nitrogen budgets and riverine N and P fluxes for the drainages to the North Atlantic ocean: natural and human influences. *Biogeochemistry*, **35**, 75–139.
- Howarth, R. W., Boyer, E. W., Marino, R. *et al.* (2006). The influence of climate on average nitrogen export from large watersheds in the northeastern United States. *Biogeochemistry*, **79**, 163–186.
- Humborg, C., Danielsson, A., Sjöberg, B. and Green, M. (2003). Nutrient land-sea fluxes in oligotrophic and pristine estuaries of the Gulf of Bothnia, Baltic Sea. *Estuarine, Coastal and Shelf Science*, **56**, 781–793.
- Humborg, C., Smedberg, E., Blomqvist, S. *et al.* (2004). Nutrient variations in boreal and subarctic Swedish rivers: landscape control of land-sea fluxes. *Limnology and Oceanography*, **49**, 1871–1883.
- Humborg, C., Pastuszak, M., Aigars, J. *et al.* (2006). Decreased silica land-sea fluxes through damming in the Baltic Sea catchment: significance of particle trapping and hydrological alterations. *Biogeochemistry*, **77**, 265–281.
- Humborg, C., Smedberg, E., Rodriguez Medina, M., Mörth, C.-M. (2008). Changes in dissolved silicate loads to the Baltic Sea – The effects of lakes and reservoirs *Journal Marine Systems*. **73**: 223–235
- Johnes, P. J. and Butterfield, D. (2002). Landscape, regional and global estimates of nitrogen flux from land to sea: errors and uncertainties. *Biogeochemistry*, **57/58**, 429–476.
- Justic, D. (1991). Hypoxic conditions in the northern Adriatic sea: historical development and ecological significance. *Geological Society of London, Special Publications*, **58**, 95–105
- Justic, D., Rabalais, N. N., Turner, R. E. and Dortch, Q. (1995). Changes in nutrient structure of river-dominated coastal waters, stoichiometric nutrient balance and its consequences. *Estuarine and Coastal Shelf Science*, **40**, 339–345.
- Kelly, C. A., Rudd, J. M., Hesslein, R. H. *et al.* (1987). Prediction of biological acid neutralization in acid-sensitive lakes. *Biogeochemistry*, **3**, 129–140.
- Kortelainen, P., Mattsson, T., Finer, L. *et al.* (2006). Controls on the export of C, N, P and Fe from undisturbed boreal catchments, Finland. *Aquatic Sciences*, **68**, 453–468.
- Kronvang, B., Borgvang, S. A. and Barkved, L. J. (2009). Towards European harmonised procedures for quantification of nutrient losses from diffuse sources: the EUROHARP project. *Journal of Environmental Monitoring*, **11**, 503–505.
- Lancelot, C. (1995). The mucilage phenomenon in the continental coastal waters of the North Sea. *Science of the Total Environment*, **165**, 83–102.
- Lancelot, C., Billen, G., Sournia, A. *et al.* (1987). *Phaeocystis* blooms and nutrient enrichment in the continental coastal zones of the North Sea. *Ambio*, **16**, 38–46.
- Lancelot, C., Billen, G. and Barth, H. (1991). *The Dynamics of Phaeocystis Blooms in Nutrient Enriched Coastal Zones*, Water Pollution Research Reports Series No. 23, Environmental RD Programme, CEC, Brussels.
- Lancelot, C., Martin, J. M., Panin, N. and Zaitsev, Y. (2002). The North-Western Black-Sea: a pilot site to understand the complex interaction between human activities and the coastal environment. *Estuarine, Coastal and Shelf Science*, **54**, 279–283.
- Lancelot, C., Spitz, Y. and Gypens, N. *et al.* (2005). Modelling diatom-*Phaeocystis* blooms and nutrient cycles in the Southern Bight of the North Sea: the MIRO model. *Marine Ecology Progress Series*, **289**, 63–78.
- Lancelot, C., Gypens, N., Billen, G., Garnier, J. and Roubex, V. (2007). Testing an integrated river-ocean mathematical tool for linking marine eutrophication to land use: The *Phaeocystis*-dominated Belgian coastal zone (Southern North Sea) over the past 50 years. *Journal of Marine Systems*, **64**, 216–228.
- Law, C. S. Rees, A. P. and Owens N. J. P. (1992). Nitrous oxide: estuarine sources and atmospheric flux. *Estuarine, Coastal and Shelf Science*, **35**, 301–314.
- Leip, A., Achermann, B., Biller, G. *et al.* (2011). Integrating nitrogen fluxes at the European scale. In: *The European Nitrogen Assessment*, ed. M. A. Sutton, C. M. Howard, J. W. Erisman *et al.*, Cambridge University Press.
- Lepistö, A., Kenttämies, K. and Rekolainen, S. (2001) Modeling combined effects of forestry, agriculture and deposition on nitrogen export in a northern river basin in Finland. *Ambio*, **30**, 338–348.
- Lepistö, A., Granlund, K., Kortelainen, P. and Räike, A. (2006). Nitrogen in river basins: Sources, retention in the surface waters and peatlands, and fluxes to estuaries in Finland. *Science of the Total Environment*, **365**, 238–259.
- Leppäranta, M. and Myrberg, K. (2009). *Physical Oceanography of the Baltic Sea*. Springer, New York.

- Ludwig, W., Dumont, E., Meybeck, M. and Heussner, S. (2009). River discharges of water and nutrients to the Mediterranean and Black Sea: major drivers for ecosystem changes during past and future decades? *Progress in Oceanography*, **80**, 199–217.
- Lundberg, C. (2005). Conceptualizing the Baltic Sea ecosystem an interdisciplinary tool for environmental decision making. *Ambio*, **34**, 433–439.
- Marchetti, R. (1990). Algal blooms and gel production in the Adriatic sea. In: Barth, H., Fegan, L. (eds.) *Eutrophication Related Phenomena in the Adriatic Sea and in other Mediterranean Coastal Zones*, Water Pollution Research Reports Series No. 16, Environmental RD Programme, CEC, Brussels, pp. 21–42.
- Mattsson, T., Finer, L., Kortelainen, P. and Sallantausta, T. (2003). Brook water quality and background leaching from unmanaged forested catchments in Finland. *Water, Air and Soil Pollution*, **147**, 275–297.
- Mayorga, E., Seitzinger, S. P., Harrison, J. A. et al. (2010). Global Nutrient Export from Watersheds 2 (NEWS 2): model development and implementation. *Environmental Modeling and Software*, **25**, 837–853.
- Mee, L. D. (1992). The Black Sea in crisis: the need for concerted international action. *Ambio*, **21**, 278–286.
- Meybeck, M., Cauwet, G., Dessery, S. et al. (1988). Nutrients (organic C, P, N, Si) in the eutrophic River Loire (France) and its estuary. *Estuarine Coastal and Shelf Science*, **27**, 595–624.
- Meybeck, M. and Dürr, H. H. (2009). Cascading filters of river material from headwaters to regional seas: the European example. In *SCOPE 70*, Chapter 7.
- Murata, A., Sandric Chee Yew Leonga, Yuji Nagashima, Y. and Taguchi, S. (2006). Nitrogen: phosphorus supply ratio may control the protein and total toxin of dinoflagellate *Alexandrium tamarense*. *Toxicon*, **48**, 683–689.
- Neal, C. and Davies, H. (2003). Water quality fluxes for eastern UK rivers entering the North Sea: a summary of information from the Land Ocean Interaction Study (LOIS). *Science of the Total Environment*, **314/316**, 821–882.
- Neitsch, S. L., Arnold, J. G., Kiniry, J. R. and Williams, J. R. (2001). *Soil and Water Assessment Tool-use Manual Version 2000*. Blackland Research Center, Agricultural Research Service, Texas, USA.
- Neitsch, S. L., Arnold, J. G., Kiniry, J. R. and Williams, J. R. (2005). *SWAT Theoretical Documentation*. www:bcr.tamus.edu/swat/
- Nielsen, K., Nielsen, L. P. and Rasmussen, P. (1995). Estuarine nitrogen retention independently estimated by the denitrification and mass balance methods: a study of Norsminde Fjord, Denmark. *Marine Ecology Progress Series*, **119**, 275–283.
- Nixon, S. W., Ammerman, J. and Atkinson, L. (1996). The fate of nitrogen and phosphorus at the land–sea margin of the North Atlantic Ocean. *Biogeochemistry*, **35**, 141–180.
- Officer, C. B. and Ryther, J. H. (1980). The possible importance of silicon in marine eutrophication. *Marine Ecology Progress Series*, **3**, 383–391.
- OSPAR (2002). *Data Report on the Comprehensive Study of Riverine Inputs and Direct Discharges (RID) in 2000*. OSPAR Commission, London.
- Pastuszak, M., Witek, Z., Nagel, K., Wielgat, M. and Grelowski, A. (2005). Role of the Oder estuary (southern Baltic) in transformation of the riverine nutrient loads. *Journal of Marine Systems*, **57**, 30–54.
- Peterson, B. J., Wollheim, W. M., Mulholland, P. J. et al. (2001). Control of nitrogen export from watersheds by headwater streams. *Science*, **292**, 86–90.
- Pettine, M., Patrolocco, L., Camusso, P. and Crescenzo, S. (1998). Transport of carbon and nitrogen to the northern Adriatic Sea by the Po River. *Estuarine, Coastal and Shelf Science*, **46**, 127–142.
- Pitkänen, H. and Tamminen, T. (1995). Nitrogen and phosphorus as production limiting factors in the estuarine waters of the eastern Gulf of Finland. *Marine Ecology Progress Series*, **129**, 283–294.
- Pitkänen, H., Lehtoranta, J. and Räike, A. (2001). Internal nutrient fluxes counteract decreases in external load: the case of the estuarial eastern Gulf of Finland, Baltic Sea. *Ambio*, **30**, 195–201.
- Preston, D. P. and Brakebill, J. W. (1999). *Application of Spatially Referenced Regression Modeling for the Evaluation of Total Nitrogen Loading in the Chesapeake Bay Watershed*, (WRI Report 99–4054. USGS Water Resources Division MD-DE-DC, Maryland).
- Radach, G. and Pätsch, J. (2007). Variability of continental riverine freshwater and nutrient inputs into the North Sea for the years 1977–2000 and its consequences for the assessment of eutrophication. *Estuaries and Coasts*, **30**, 66–81.
- Rantakari, M. and Kortelainen, P. (2008). Controls of organic and inorganic carbon in randomly selected Boreal lakes in varied catchments. *Biogeochemistry*, **91**, 151–162.
- Redfield, A. C., Ketchum, B. H., Richards, F. A. (1963). *The influence of organisms on the composition of sea-water*. In: *The Sea*, ed. M. N. Hill, John Wiley & Sons, New York, pp. 12–37.
- REGINE (2010). www.nve.no
- Ruelland, D., Billen, G., Brunstein, D. and Garnier, J. (2007). SENEQUE 3: a GIS interface to the RIVERSTRAHLER model of the biogeochemical functioning of river systems. *Science of the Total Environment*, **375**, 257–273.
- Sangiorgi, F. and Donders, T. H. (2004). Reconstructing 150 years of eutrophication in the north-western Adriatic Sea (Italy) using dinoflagellate cysts, pollen and spores. *Estuarine, Coastal and Shelf Science*, **60**, 69–79.
- Schouwman, O. F., Silgram, M. P., Groenendijk, P. et al. (2003). Description of nine nutrient loss models: capabilities and suitability based on their characteristics. *Journal of Environmental Monitoring*, **11**, 506–514.
- Seitzinger, S. P., Mayorga, E., Kroeze, C. et al. (2009). Global river nutrient export trajectories 1970–2050: a millennium ecosystem assessment scenario analysis. *Global Biogeochemical Cycles*, doi:10.1029/2009GB003587.
- Sferratore, A., Garnier, J., Billen, G., Conley, D. and Pinault, S. (2006). Silica diffuse and point sources in the Seine watershed. *Environmental Science and Technology*, **40**, 6630–6635.
- Smith, R. A., Schwarz, G. E. and Alexander, R. B. (1997). Regional interpretation of water-quality monitoring data. *Water Resources Research*, **33**, 2781–2798.
- Solidoro, C., Bastianini, M., Bandelj, V. et al. (2009). Current state, scales of variability, and trends of biogeochemical properties in the northern Adriatic Sea. *Journal of Geophysical Research*, **114**, doi:10.1029/2008JC004838.
- Stalnacke, P., Grimvall, A., Libiseller, C., Laznik, M. and Kokorite, I. (2003). Trends in nutrient concentrations in Latvian rivers and the response to the dramatic change in agriculture. *Journal of Hydrology*, **283**, 184–205.
- Tamminen, T. and Andersen, T. (2007). Seasonal phytoplankton nutrient limitation patterns as revealed by bioassays over Baltic Sea gradients of salinity and eutrophication. *Marine Ecology Progress Series*, **340**, 121–138.
- Thieu, V., Billen, G. and Garnier, J. (2009). Nutrient transfer in 3 contrasting N-W European watersheds: the Seine, Somme and Scheldt rivers. A comparative application of the Senèque/Riverstrahler model. *Water Resources Research*, **43**, 1740–1748.
- Thieu, V., Garnier, J. and Billen, G. (2010a). Assessing the effect of nutrient mitigation measures in the watersheds of the Southern Bight of the North Sea. *Science of the Total Environment* (in press).

- Thieu, V., Billen, G., Garnier, J. and Benoit, M. (2010b). Nutrient cycling in a hypothetical scenario of generalized organic agriculture in the Seine, Somme and Scheldt watersheds. *Regional Environmental Changes* (in press).
- Trifu-Raducu, M.-C. (2002) Transfert des nutriments dans le bassin du Danube et apports à la Mer Noire: modélisation et bilans. Thèse, Université P & M Curie. Paris
- Turner, R. E. and Rabalais, N. N. (1994). Evidence for coastal eutrophication near the Mississippi River Delta. *Nature*, **368**, 619–621.
- Turner, R. E., Qureshi, N. A., Rabalais, N. N. *et al.* (1998). Fluctuating silicate:nitrate ratios and coastal plankton food webs. *Proceedings of the National Academy of Sciences of the USA*, **95**, 13048–13051.
- Vasas, V., Lancelot, C., Rousseau, V. and Jordan, F. (2007). Eutrophication and overfishing in temperate nearshore pelagic food webs: a network perspective. *Marine Ecology Progress Series*, **336**, 1–14.
- Voss, M., Baker, A. and Bange, H. W. (2011). Nitrogen processes in coastal and marine systems. In: *The European Nitrogen Assessment*, ed. M. A. Sutton, C. M. Howard, J. W. Erisman *et al.*, Cambridge University Press.
- Wade, A. J., Durand, P., Beaujouan, V. *et al.* (2002a). A nitrogen model for European catchments: INCA, new model structure and equations. *Hydrology and Earth System Sciences*, **6**, 559–682.
- Wade, A. J., Whitehead, P. G. and Butterfield, D. (2002b). The Integrated Catchments model of phosphorus dynamics (INCA-P), a new approach for multiple source assessment in heterogeneous river systems: model structure and equations. *Hydrology and Earth System Sciences*, **6**, 583–606.
- Whitehead, P. G., Wilson, E. J. and Butterfield, D. (1998). A semi-distributed Nitrogen Model for Multiple Source Assessments in Catchments (INCA): Part 1 – Model Structure and Process Equations. *Science of the Total Environment*, **210/211**, 547–558.
- Windolf, J., Jeppesen, E., Jensen, J. P. and Kristensen, P. (1996). Modelling of seasonal variation in nitrogen retention and in-lake concentration: a four-year mass balance study in 16 shallow Danish lakes. *Biogeochemistry*, **33**, 25–44.